

# Call and Connections Times in ASON/GMPLS Architecture

Sylwester Kaczmarek, Magdalena Młynarczyk, and Paweł Zieńko

*Faculty of Electronics, Telecommunications and Informatics, Gdańsk University of Technology, Gdańsk, Poland*

**Abstract**—It is assumed that demands of information society could be satisfied by architecture ASON/GMPLS comprehended as Automatically Switched Optical Network (ASON) with Generalized Multi-Protocol Label Switching (GMPLS) protocols. Introduction this solution must be preceded by performance evaluation to guarantee society expectations. Call and connections times are in ASON/GMPLS architecture important for real-time applications. Practical realization is expensive and simulations models are necessary to examine standardized propositions. This paper is devoted to the simulation results of ASON/GMPLS architecture control plane functions in OMNeT++ discrete event simulator. The authors make an effort to explore call/connection set-up times, connection release times in a single domain of ASON/GMPLS architecture.

**Keywords**—ASON, call control, call time, connection control, connection time, GMPLS, simulation model.

## 1. Introduction

Continuous information growth concerned with sophisticated applications generates the necessity of new telecommunication network architecture proposition based on optical solutions. The ITU-T Automatically Switched Optical Network (ASON) [1] concept with Generalized Multi-Protocol Label Switching (GMPLS) [2], [3] protocols has a chance to fulfill information society requirements. This solution is named as ASON/GMPLS.

The ASON/GMPLS control plane is composed of different components that provide specific functions (including routing and signaling). The main purpose of ASON/GMPLS control plane is to facilitate fast and efficient configuration of connections within a transport layer network to support both switched and soft permanent connections using GMPLS protocols like RSVP-TE [4], [5] for signaling and OSPF-TE for routing [6], [7]. The basic assumption of ASON control plane is a separation of call control from connection control. This separation makes it possible to control plane to be completely separate from transport plane.

The ASON architecture itself is only a concept. The advantages of this architecture are presented in [8]. The reference ASON control plane architecture describes the functional components including abstract interfaces and primitives. The recommendation presents interactions between call controller components, interactions among components during connection set-up and interactions among components during connection release. It also defines

a functional component that transforms the abstract component interface into protocols. For a time being the standardization does not specify all protocols details needed to implementation.

Using GMPLS protocols or even mechanism of protocols gives the opportunity to ASON/GMPLS realization. Practical realizations are made only for simple network architecture [9]. For complex research simulations models are needed.

The aim of the paper is to present a series of simulation results to show the performance of ASON/GMPLS control plane functions to support switched connections and discuss the problem of call/connection set-up time and connection release time in a single domain. The work on simulation model has been preceded by practical realizations of ASON/GMPLS architecture in a laboratory testbed presented in [9], [10]. Performed tests validated correctness of all network elements operations including communication procedures and request processing. The same communication procedures are implemented in the simulation model with respect to ASON/GMPLS standardization and the latest trends in ITU-T NGN architecture [11]. The paper is organized as follows. General information about ASON/GMPLS architecture and basic control functions scenarios are depicted in Section 2. The ASON/GMPLS simulation model is presented in Section 3. Section 4 is devoted to presentation of performance tests results including call and connections times and loss probabilities. Conclusions and outlook to future are presented in Section 5.

## 2. Basic Control Plane Scenarios

### 2.1. ASON/GMPLS Control Plane Concept

This section is devoted to description of ASON recommendation and GMPLS protocols mechanisms proposed in ASON/GMPLS.

The idea of call and connection control is presented in [1]. The ASON recommendation separates the treatment of call and connection control. The call is a representation of the service offered to the user of a network, while connections are one of the means by which networks deliver required services. The ASON/GMPLS control plane is equipped with call and connection components.

The components concerned with call service are Calling/Called Party Controller (CCC) and Network Call Controller (NCC). The main roles of the CCC are call gener-

ation of call requests, acceptance or rejection of incoming call requests, generation of call termination requests. The CCC component is associated with the end of the call. The NCC component supports for calling and called party controllers and additionally supports calls at domain boundaries. Apart from call components ASON/GMPLS control plane is equipped with components involved in connection control like: Routing Controller (RC), Protocol Controller (PC), Connection Controller (CC), Link Resource Manager (LRM), Termination and Adaptation Performer (TAP). As recommended in [1] the Connection Controller is responsible for coordination among the Link Resource Manager, the Routing Controller and other Connection Controllers for the purpose of set-up, release and modification of connection. The Routing Controller provides routing functions using GMPLS routing protocol. The Link Resource Manager maintains the network topology. The role of the Protocol Controller is to map the operation of the components in the control plane into messages that are carried by GMPLS communication protocol between interfaces in the control plane. The Termination and Adaptation Performer holds the identifiers of resources that can be managed using the control plane interfaces. The group of components involved in connection control is considered in further sections as Control Element (CE).

Assumed that ASON/GMPLS control plane is equipped with two CCC (CCC\_1 and CCC\_2), NCC, three CE (CE\_1, CE\_2, CE\_3) and transport plane is represented by three optical cross-connects (OXC\_1, OXC\_2 and OXC\_3) the ASON/GMPLS architecture is presented in Fig. 1.

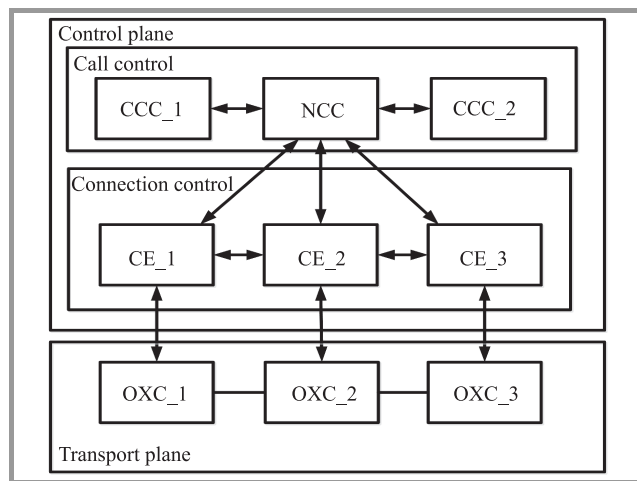

Fig. 1. The ASON/GMPLS network architecture.

The CE<sub>i</sub> element is a representation of control elements for OXC<sub>i</sub> (i = 1, 2, 3). The set-up and release scenario is performed by control plane components including call components and connection components.

2.2. Call/connection Set-up Scenario

In this section the authors want to present typical call/connections set-up scenario based on [4]. The same scenario

is implemented in the simulation model. The scenario is graphical presented with definition of times necessary to calculate call set-up time, connection set-up time. The basic set-up scenario is presented in Fig. 2. The call set-up requests are sent by CCC\_1. The Calling Party Controller CCC\_1 sends a *call\_request* to NCC. The NCC component sends *call\_indication* to the Called Party Controller CCC\_2. The CCC\_2 component after call confirmation initiates connection set-up process sending *connection\_request* to CE\_1. Then communication between CE elements is performed by RSVP-TE signaling messages sending Path and Resv messages according to [4] until it reaches destination CE\_3. After successful connection set-up in the transport plane CE\_1 informs NCC sending *connection\_confirmed*. Finally NCC sends *call\_confirmed* to the Calling Party Call Controller.

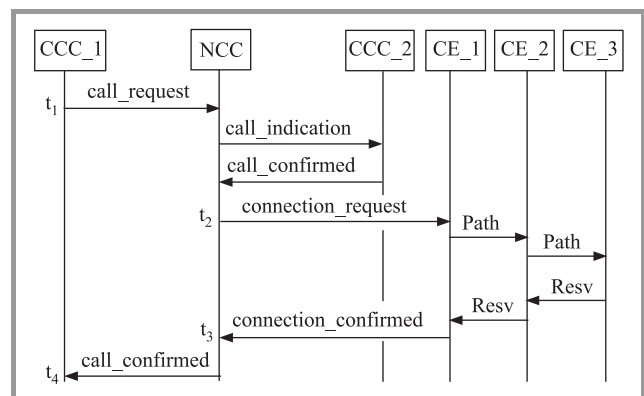

Fig. 2. The set-up scenario for ASON/GMPLS architecture.

Taking into consideration the call/connection set-up scenario presented in Fig. 2 value of call set-up time is defined as time from sending *call\_request* (t<sub>1</sub>) up to *call\_confirmed* (t<sub>4</sub>) while connection set-up time is defined as time from sending *connection\_request* (t<sub>2</sub>) to *connection\_confirmed* (t<sub>3</sub>).

2.3. Connection Release Scenario

The basic release scenario is performed as depicted in Fig. 3. The value of call connection release time is defined as time from sending *call\_release* (t<sub>5</sub>) up to *release\_confirmed* (t<sub>8</sub>) while connection release time is defined as time from sending *connection\_release* (t<sub>6</sub>) to *connection\_release\_confirmed* (t<sub>7</sub>).

In the case of connection release ITU-T standardization group distinguishes release scenarios initiated by different call controllers [4]. The release request could be initiated by call controllers, e.g., Calling Party Call Controller, Called Party Call Controller, or any one of Network Call Controllers. The illustrations of various release requests are presented in [4]. In the release scenario presented in Fig. 3 the release request is initiated by Calling Party Controller CCC\_1 by sending *call\_release*. According to release scenarios in [4] the Path\_release message repre-

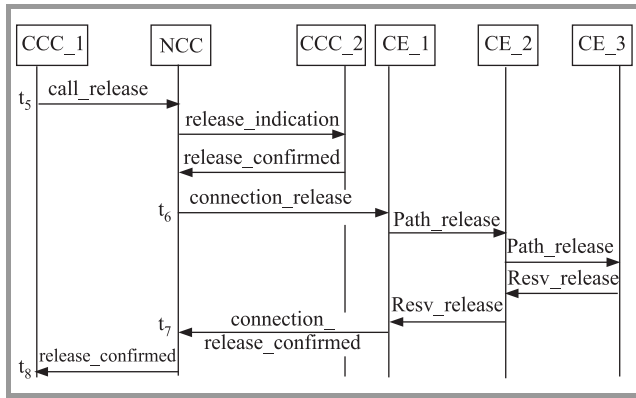

Fig. 3. The release scenario for ASON/GMPLS.

sents Path message. The Resv\_release messages represents PathErr with Path\_State\_Removed flag.

### 3. Simulation Model

The ASON/GMPLS simulation model is created in OM-NeT++ environment [12]. It consists six main functional blocks:

- control plane,
- transport plane,
- call generation,
- topology and resource information,
- initial configuration,
- measurements.

The control plane block consists of functional elements like: the Connection Controller (CC), the Routing Controller (RC), the Link Resource Manager (LRM), the Calling/Called Party Controller (CCC), the Network Call Con-

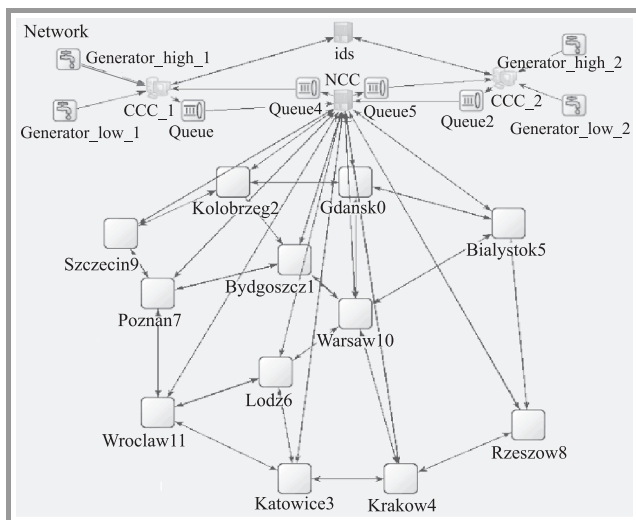

Fig. 4. The structure of simulated network Poland.

troller (NCC). The transport plane block emulates Optical Cross-Connects (OXCs) operations. For each OXC blocking probability is assumed. Signaling is performed on separate wavelength. Resource allocation takes into consideration Routing and Wavelength Assignment problem (RWA) [13]. Routing functions are implemented in accordance with [1], [6].

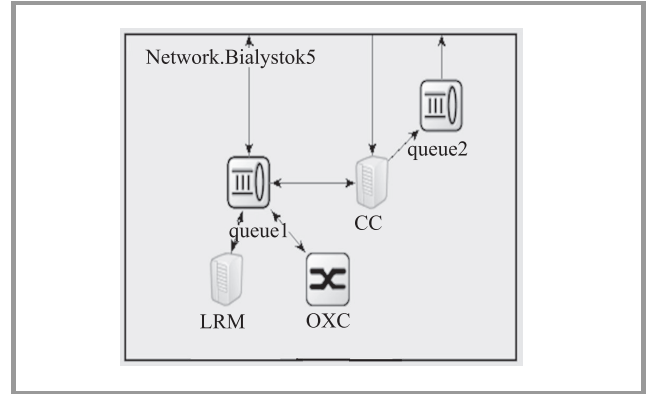

Fig. 5. The structure of node Bialystok.

Control plane functions in the simulation model are divided into call control functions and connection control functions. Call control functions concerned with call processing and connection control functions are responsible for set-up and release connections in transport plane. The call control plane is not aware of transport plane topology. The structure of the control plane model is presented in Fig. 4. The structure of node consists of control plane elements and OXC is presented in Fig. 5. In the simulation model the physical link is simulated by the single module which has a queue and a link as a representation of propagation delay. The model of ASON control plane functions is based on the following assumptions:

- call control functions are represented by elements: two Calling/Called Party Controllers (CCC\_1, CCC\_2), Network Call Controller (NCC), ids,
- connection control function are performed by Control Elements (CE),
- the Control Element consists of the Connection Controller (CC), the Routing Controller (RC), the Link Resource Manager (LRM), the Termination and Adaptation Performer (TAP) (see Fig. 5),
- the number of the CE is equal to the number of nodes,
- mapping of the CE to transport plane (represented as emulated OXC) is one-to-one.

The transport plane has separate resources for high and low priority requests (20% recourses are for high priority requests).

As is depicted in Fig. 4 generation block is represented by components: generator\_high\_1, generator\_low\_1, generator\_high\_2 and generator\_low\_2. The generator\_high\_1 and generator\_low\_1 generate requests with high and low

priority respectively with defined distribution and send towards CCC\_1, while generator\_high\_2 and generator\_low\_2 send high and low priority requests towards CCC\_2. CCC\_1 and CCC\_2 send received requests to ids, which assigns unique call identifier (Call\_ID) to generated call requests. Afterwards Call\_ID is located in the call request and send to NCC. The process of call processing is presented in Fig. 6.

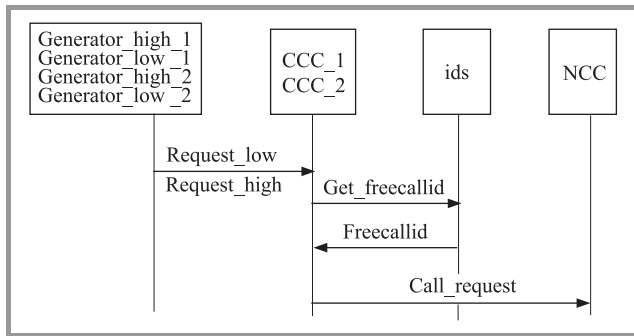

Fig. 6. The call control in ASON/GMPLS control plane.

The topology and resource information block is in charge of storage control plane topology, transport plane topology, domain allocation (links, distance between nodes). All parameters including network topology are configurable during initial configuration. To make realistic network conditions the topology is based on [14].

Due to initial configuration block we are able to set initial values for:

- call generator (distributions of call requests for low/high priority, distribution of connection release for low/high priority),
- traffic matrix (coefficient matrix),
- measurement and run the simulation (i.e., simulation time limit, warm-up period, event log module recording, seed, call time distribution),
- control plane (assignment sources addresses to nodes, assignment unique id number to each node),
- transport plane (blocking probability of OXC).

The measurements are performed in NCC component and ids. The ids is responsible for call set-up measurement, call release measurement. The NCC component is responsible for call release measurement, connection release measurement. Necessary times depicted in Fig. 2 and Fig. 3 ( $t_1-t_8$ ) to calculate call/connection set-up/release times are stored in .vec files. The simulation execution consists of warm-up period and n measurements periods. Comprehensive statistical analysis is performed offline based on .vec files.

Taking into consideration the presented model and call/connection set-up and release scenarios presented in Section 2, the simulation model makes it possible to

evaluate connection loss probability. The connection loss probability could be caused by lack of optical resources or blocking probability of OXC.

## 4. Control Plane Performance Results and Discussion

The performance evaluation of control plane functions in ASON/GMPLS is presented by performance results. The simulation scenario includes call and connection set-up times and connection release times which were estimated using t-Student distribution with confidence level equal 0.95. The confidence intervals are low and they aren't marked. The simulation was executed for a single domain Poland network using following assumptions:

- total simulation time: 3600 s,
- warm-up period: 200 s,
- 15 measurements intervals,
- exponential distribution of call request,
- exponential distribution of connection release requests,
- 20% of all generated requests are high priority,
- mean connection duration time (ConnD): 15 minutes, 30 minutes,
- blocking probability of OXC: 0.001,
- signaling link capacity 10 Mbit/s,
- wavelength capacity: 1 Gbit/s
- capacity of single connection requests: 5 Mbit/s, 10 Mbit/s, 15 Mbit/s,
- the number of wavelengths per fiber: 40.

In the simulation Poland topology was assumed with shortest path algorithm (Dijkstra) for routing. The section presents exemplary results based on OMNeT++ simulations.

### 4.1. Call/connection Set-up Results

Results presented in Figs. 7–8 (for connection duration 30 minutes) indicate that mean values of call set-up time and connection set-up time significantly depend on request intensity assumed as the sum of call/connection set-up requests and connection release requests. Mean values of call/connection set-up time are presented for: all generated call/connection set-up requests, call/connection set-up requests successful ended and for call/connection set-up requests unsuccessful ended. Unsuccessful connection set-up request results from lack of free resources in emulated transport plane or blocking probability of OXC.

All call set-up times and connection set-up times have tendency to low in the range from 300 requests per second to 9700 request per second with rapid growth of connection loss probability. For intensities smaller than 700 re-

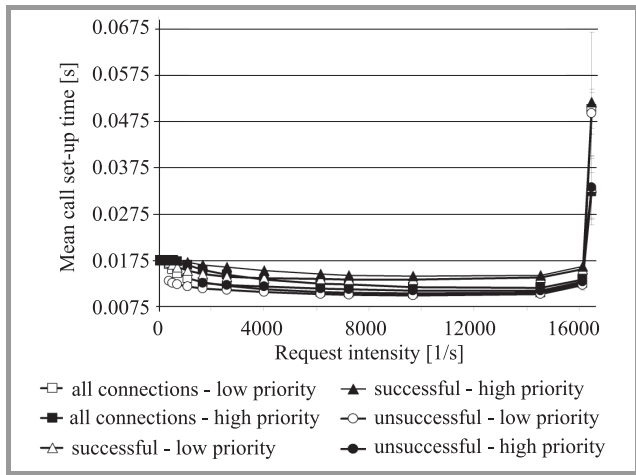

Fig. 7. Mean call set-up time.

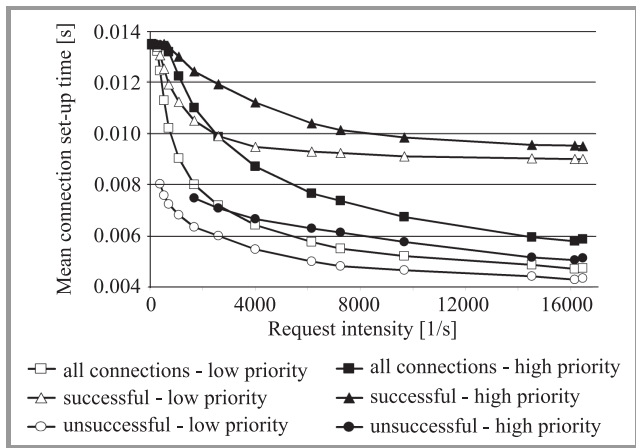

Fig. 8. Mean connection set-up time.

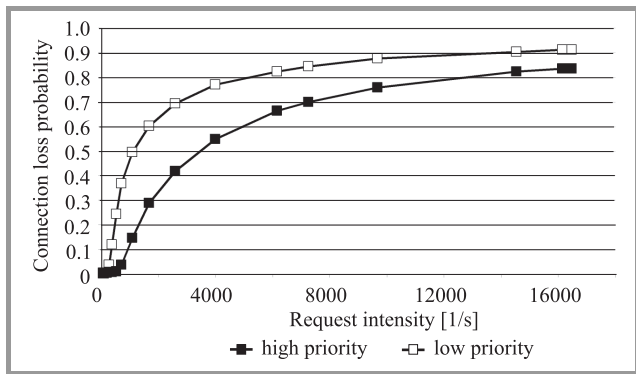

Fig. 9. Connection loss probability.

quests per second loss probability for high priority requests is smaller than 0.04. Detailed analysis of the OMNeT++ event log verified that for intensity greater than 1000 requests per second successful connections were established to the nearest nodes. This effects smaller call/connection set-up time. For intensity greater than 9700 requests per second the bandwidth of signaling link was too small to service call traffic. The greater intensity is, the longer the waiting times for RSVP messages send between control plane components. Additionally, results presented in Fig. 9 indicate that the connection loss probability for in-

tensity 1098 requests per second is equal 0.15 for high priority connection requests and 0.5 for low priority connection requests. For high priority connection requests and intensities 290, 392, 700 requests per second loss probabilities equal 0.04, 0.1 and 0.3 respectively. For low priority connection request loss probabilities 0.04, 0.1, 0.3 are for intensities 714, 1000, 1690 requests per second respectively. Figure 10 presents loss probabilities for connection

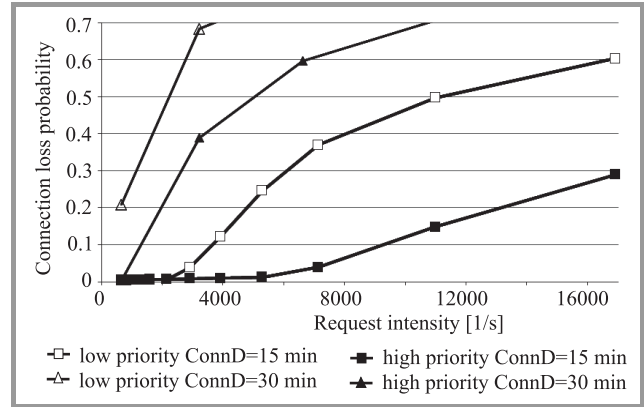

Fig. 10. Connection loss probability.

duration time (ConnD) equals 15 minutes and connection duration time (ConnD) equals 30 minutes. The call set-up time and connection set-up time decrease is caused by reducing amount of connections on long distance and high loss probability equal more than 0.3. Additionally, the path computation algorithm takes into consideration distance and RWA requirements. Due to this for greater intensity more often shortest connections are established. In the simulation Poland topology was assumed. Taking into consideration topology and routing assumption we noticed that the majority of connections for intensities greater than 700 requests was established on shorter distance. There are more shorter connections than farther connection in Poland topology which consists of 12 nodes. The greater intensity is, the greater the number of connections to near nodes is. Figures 11–13 present number of established connections in Poland from node 0 (Gdansk) for intensity equals 65 requests per second, 714 requests per second and 9671 requests per second respectively. Figures 14–16 present number of established connections in Poland from node 3 (Katowice) for intensity equals 65 requests per second, 714 requests per second and 9671 requests per second respectively.

The greater intensity is, the greater shortage of free resources probability is. The number of established connection changes for different length of connections. The majority of connections are established with the length of connections equals two nodes.

The number of established connections from Gdansk in the length of nodes for intensity equals 65 requests per second, 714 requests per second and 9671 requests per second respectively present Figs. 17–19. The number of established connections from Katowice in the length of nodes for

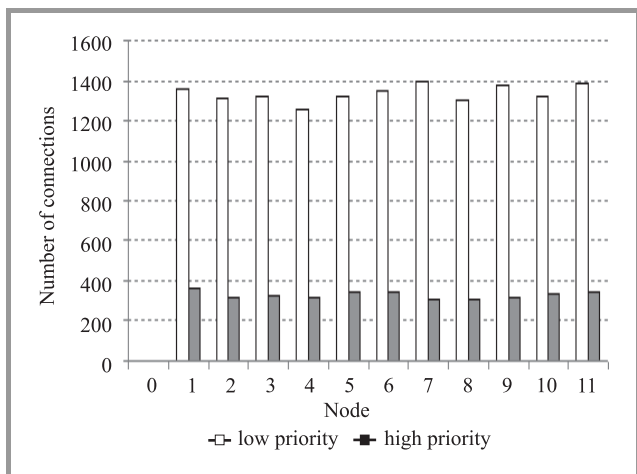

Fig. 11. The number of connections from Gdansk node for intensity 65 requests per second.

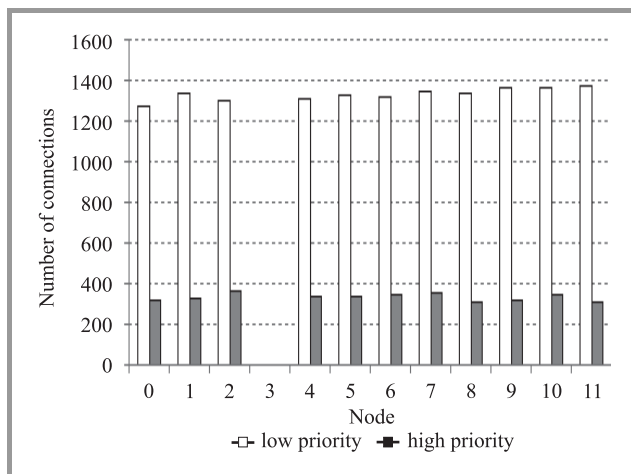

Fig. 14. The number of connections from Katowice node for intensity 65 requests per second.

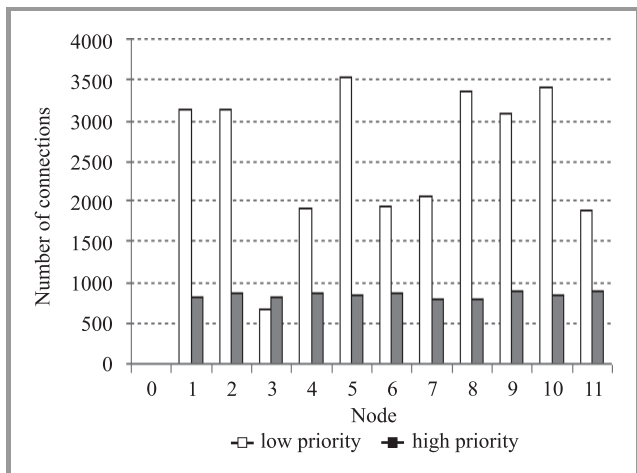

Fig. 12. The number of connections from Gdansk node for intensity 714 requests per second.

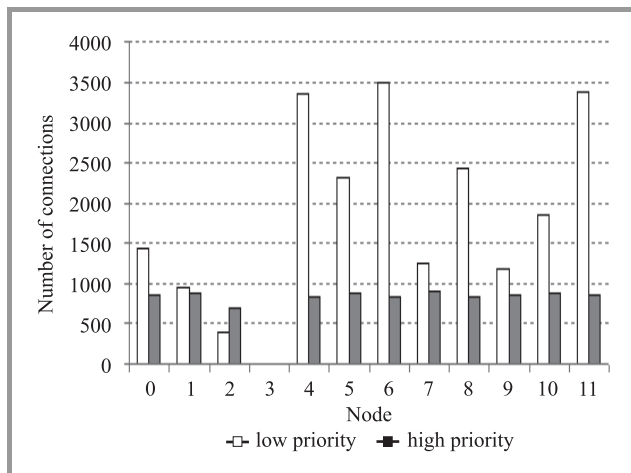

Fig. 15. The number of connections from Katowice node for intensity 714 requests per second.

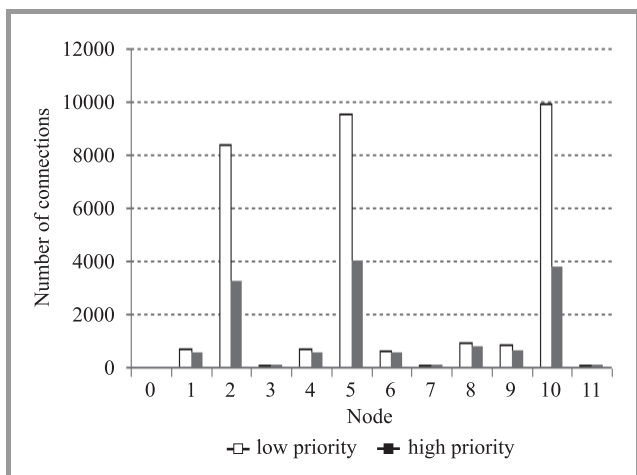

Fig. 13. The number of connections from Gdansk node for intensity 9671 requests per second.

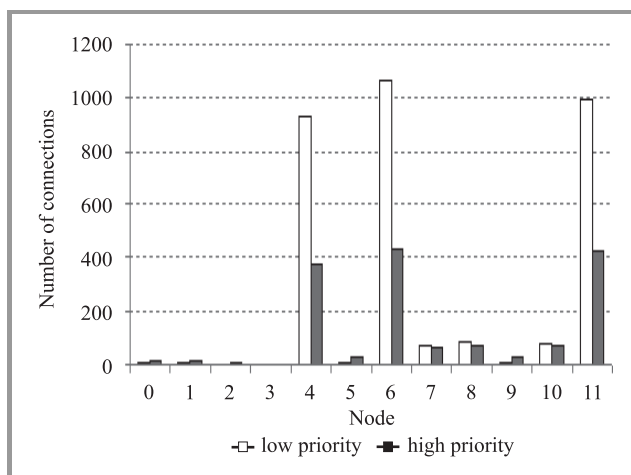

Fig. 16. The number of connections from Katowice node for intensity 9671 requests per second.

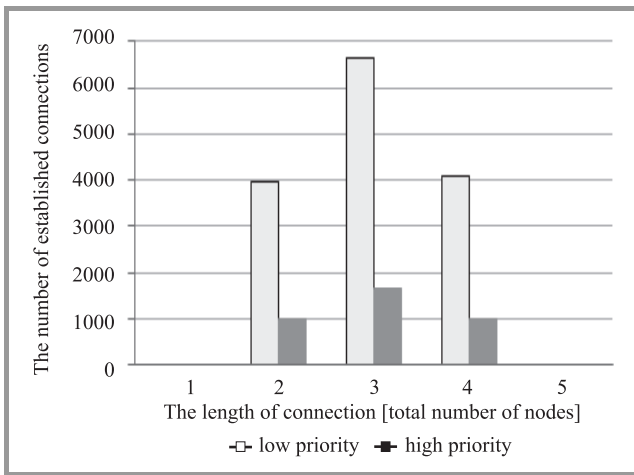

Fig. 17. The number of established connections in length of connection from Gdansk for intensity 65 requests per second.

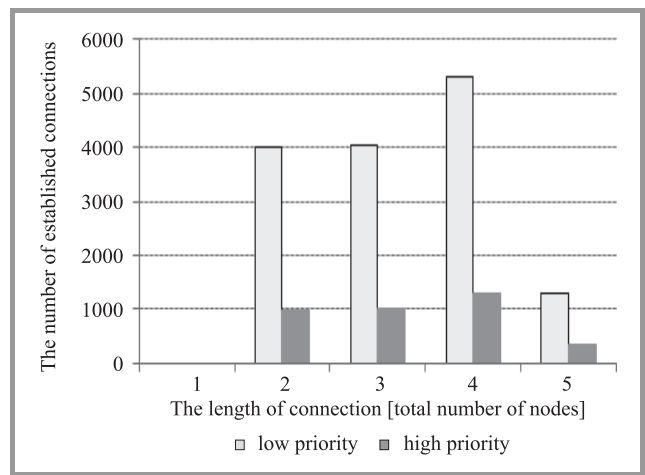

Fig. 20. The number of established connections in length of connection from Katowice node for intensity 64 requests per second.

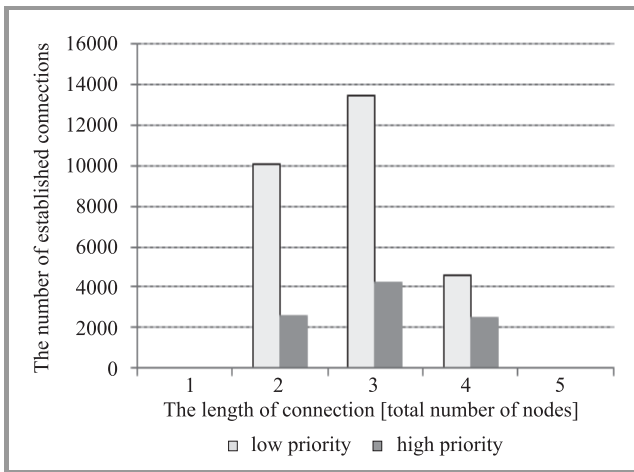

Fig. 18. The number of established connections in length of connection from Gdansk for intensity 714 requests per second.

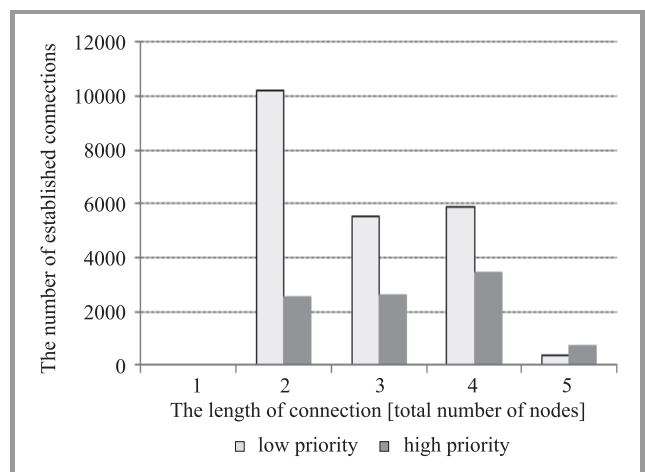

Fig. 21. The number of established connections in length of connection from Katowice node for intensity 714 requests per second.

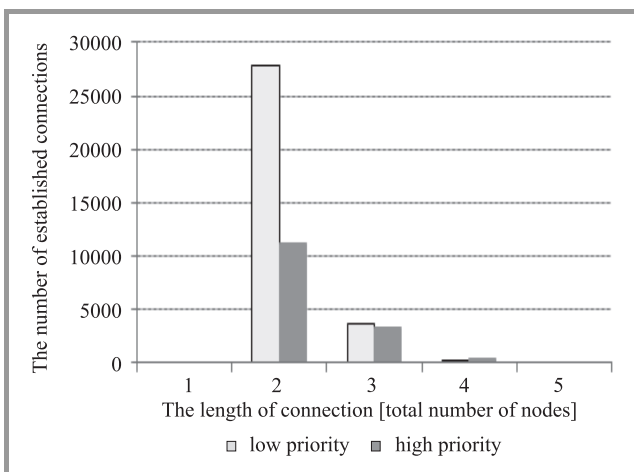

Fig. 19. The number of established connections in length of connection from Gdansk for intensity 9671 requests per second.

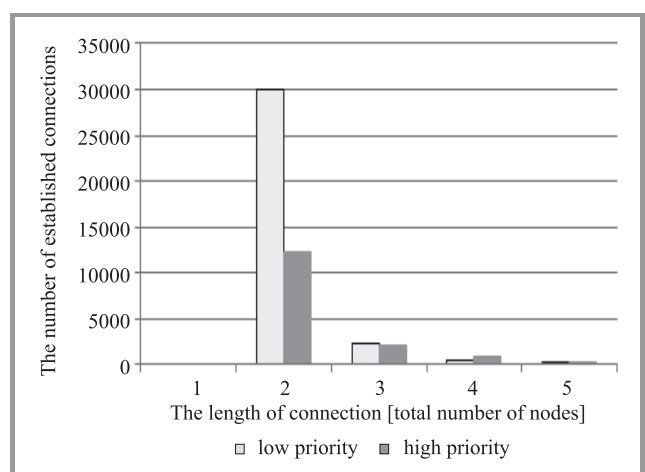

Fig. 22. The number of established connections in length of connection from Katowice node for intensity 9671 requests per second.

intensity equals 65 requests per second, 714 requests per second and 9671 requests per second respectively present Figs. 20–22. In all figures first node is a source node. As depicted in Figs. 17–22 the greater intensity requests the number of established connections in the length of three, four and five nodes decrease in comparison with connections established in the length of connection equals two nodes.

#### 4.2. Connection Release Results

Connection release time results are presented in Fig. 23 and Fig. 24. Call connection release time includes time of connection release and call release in call control of control plane. The connection release time depends on request intensity. Similar to mean values of call/connection set-up time, mean values of connection release time have tendency to low. Results presented in Fig. 23 indicate that connection release time is smaller than connection set-up time. It is associated with realizing connection scenario. The authors assumed that the control elements only sends resource release requests and do not wait for confirmation from emulated optical resources.

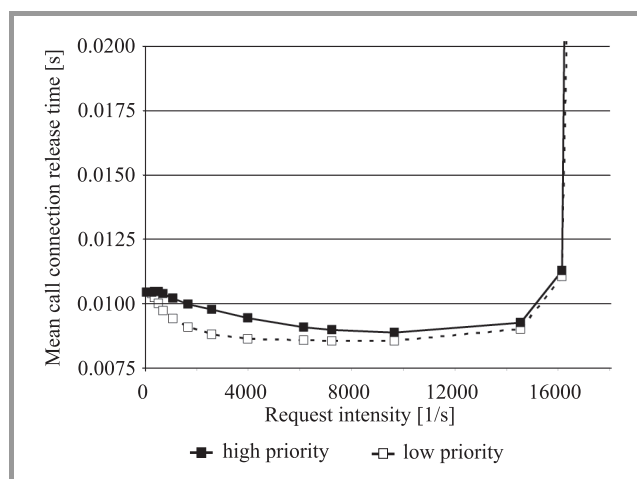

Fig. 23. Mean call connection release time.

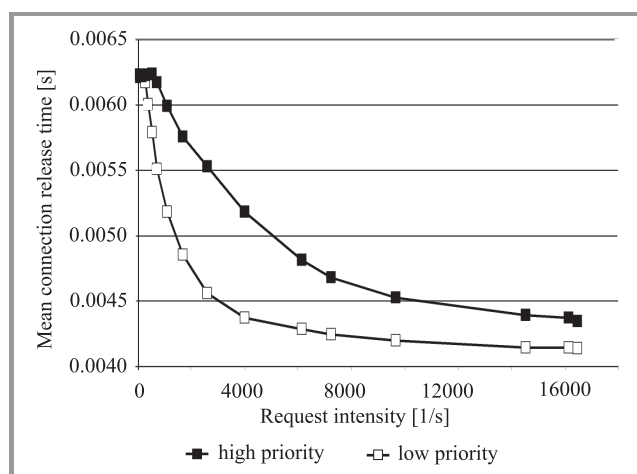

Fig. 24. Mean connection release time.

Presented in Fig. 24 results of mean connection release times indicate in the range from 300 requests per second to 7500 requests per second to decrease. In Fig. 23 for intensity greater than 7500 requests per second time of call service increases. The log analysis shows that assumed value of signaling link capacity in call control is too small and leads to rapid grow of call connection release time.

## 5. Conclusions

In the paper a simulation model of ASON/GMPLS domain architecture is presented. The model was implemented in OMNeT++ simulator, which was proved to be efficient to ASON/GMPLS application. The model allows to determine mean values of call/connection set-up time, connection release time. The results of performance evaluation of ASON/GMPLS architecture are demonstrated. Call and connections times are presented. According to simulation results, implementing ASON/GMPLS architecture leads to achieving a very high availability real time applications in Next Generation Network.

The simulation results show that the loss probability significantly increases for low priority connection requests while call/connection set-up time is shorter about 2 ms than for high priority call/connection requests. Moreover, presented results indicate the importance of routing function implementation and RWA type resource allocation mechanism. Verification by detailed analysis shows that the most chosen path was the shortest. Due to this call/connection set-up time decreases.

The model allows to simulate the impact of various network topology on processing time. Using the model many set of input variables presented in Section 3 can be changed. The model is a modular design based on compound modules and can be easily expanded. Due to space limitation, only call/connection time results for structure of Poland are presented. The structure was investigated as a single domain. The authors are in agreement that further efforts should be made into researching the relationship between time consuming concerned with multi-domain topology and call/connection set-up time and connection release time.

## Acknowledgements

This research work was partially supported by the system project “InnoDoktorant – Scholarships for PhD students, V<sup>th</sup> edition”, which is co-financed by the European Union in the frame of the European Social Fund.

## References

- [1] “Architecture for the automatically switched optical network”, ITU-T Rec. G.8080/Y.1304, Feb. 2012.
- [2] E. Mannie, “Generalized Multi-Protocol Label Switching (GMPLS) Architecture”, IETF RFC 3945, Oct. 2004.
- [3] A. Farrel and I. Bryskin, *GMPLS: Architecture and Applications*. Morgan Kaufmann, 2006.
- [4] “Distributed Call and Connection Management: Signalling mechanism using GMPLS RSVP-TE”, ITU-T Rec. G.7713.2/Y.1704.2, Mar. 2003.



- [5] OIF Guideline Document: Signaling Protocol Interworking of ASON/GMPLS Network Domains, Jun. 2008.
- [6] "ASON routing architecture and requirements for link state protocol", ITU-T Rec. G.7715.1/Y.1706.1, Feb. 2004.
- [7] "OSPF Extensions in Support of Generalized Multi-Protocol Label Switching (GMPLS)", K. Kompella and Y. Rekhter, Eds., IETF RFC 4203, Oct. 2005.
- [8] A. Jajszyzyk, "Automatically switched optical networks: Benefits and Requirements", *IEEE Opt. Commun.*, pp. 510–515, Feb. 2005.
- [9] S. Kaczmarek, M. Narloch, M. Młynarczuk, and M. Sac, "The Realization of NGN Architecture for ASON/GMPLS Network", *J. Telecommun. Inform. Technol. (JTIT)*, no. 3, pp. 47–56, 2011.
- [10] S. Kaczmarek, M. Narloch, M. Młynarczuk, and M. Sac, "Evaluation of ASON/GMPLS Connection Control Servers Performance", in *Information Systems Architecture and Technology, Service Oriented Network Systems*. Wrocław: Oficyna Wydawnicza Politechniki Wrocławskiej, 2011, pp. 267–278.
- [11] "Functional Requirements and architecture for next generation networks", ITU-T Rec. Y.2012, Apr. 2010.
- [12] "OMNeT++ Network Simulation Framework" [Online]. Available: [www.omnetpp.org](http://www.omnetpp.org)
- [13] H. Zang, J. P. Jue, and B. Mukherjee, "A Review of Routing and Wavelength Assignment Approaches for Wavelength Routed Optical WDM Networks", *Opt. Netw. Mag.*, pp. 47–60, Jan. 2000.
- [14] Network library, Zuse Institut Berlin [Online]. Available: <http://sndlib.zib.de/>

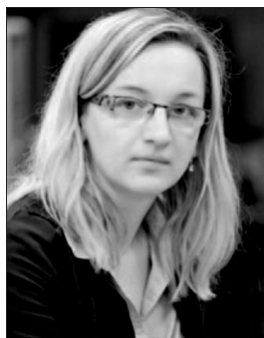

**Magdalena Młynarczuk** received her M.Sc. degree in Telecommunication Systems and Networks from Gdańsk University of Technology in 2004. Since 2008 till March 2011 she has been an assistant at Gdańsk University of Technology, Faculty of Electronics, Telecommunications and Informatics. Now she works as

lecturer at GUT. Her research interests include control of optical networks, transmission and switching technology and network design. Her doctoral thesis is entitled: "QoS Routing in multi-domain optical network with hierarchical structure control plane".

E-mail: [magdam@eti.pg.gda.pl](mailto:magdam@eti.pg.gda.pl)  
Department of Teleinformation Networks  
Faculty of Electronics, Telecommunications  
and Informatics  
Gdańsk University of Technology  
Gabriela Narutowicza st 11/12  
80-233 Gdańsk, Poland



**Paweł Zieńko** received his M.Sc. degree in Teleinformation Networks and Systems from Gdańsk University of Technology in 2012. His Master's thesis includes realization of routing simulation model in optical networks ASON/GMPLS. Since 2012 he works in Intel Technology Poland as Graphics Software Engineer.

E-mail: [pawel.zienko@interia.pl](mailto:pawel.zienko@interia.pl)  
Department of Teleinformation Networks  
Faculty of Electronics, Telecommunications  
and Informatics  
Gdańsk University of Technology  
Gabriela Narutowicza st 11/12  
80-233 Gdańsk, Poland

**Sylwester Kaczmarek** – for biography, see this issue, p. 17.