

# Compensation of Fading Channels Using Partial Combining Equalizer in MC-CDMA Systems

Mohammed Zidane<sup>1</sup>, Said Safi<sup>2</sup>, and Mohamed Sabri<sup>1</sup>

<sup>1</sup> Department of Physics, Faculty of Sciences and Technology, Sultan Moulay Slimane University, Morocco

<sup>2</sup> Department of Mathematics and Informatics, Polydisciplinary Faculty, Sultan Moulay Slimane University, Morocco

**Abstract**—In this paper the performance of a partial combining equalizer for Multi-Carrier Code Division Multiple Access (MC-CDMA) systems is analytically and numerically evaluated. In the part of channel identification, authors propose a blind algorithm based on Higher Order Cumulants (HOC) for identifying the parameters representing the indoor scenario of Broadband Radio Access Networks (BRAN A) channel model normalized for MC-CDMA systems. Theoretical analysis and numerical simulation results, in noisy environment and for different Signal to Noise Ratio (SNR), are presented to illustrate the performance of the proposed algorithm in the one hand, and the other hand the impact of partial combining equalizer on the performance of MC-CDMA systems.

**Keywords**—bit error rate, blind channel identification, higher order cumulants, MC-CDMA systems, partial combining equalizer.

## 1. Introduction

Fourth generation (4G) technology allows user to efficiently share common resources. However, the exponential growth of multimedia users request fast data rates and reliable transmission. The 4G wireless systems utilizing available limited bandwidth in a spectrally efficient manner. To attain these aims, there are two principle contending technologies, i.e. Orthogonal Frequency Division Multiplexing (OFDM) and Code Division Multiple Access (CDMA). Therefore, OFDM-CDMA and MC-CDMA gain a lot of attention for wireless mobile communication [1]–[2]. The principles of MC-CDMA [3] is that a single data symbol is transmitted on multiple narrow band subcarriers. Indeed, in MC-CDMA systems, spreading codes are applied in the frequency domain and transmitted over independent subcarriers. However, multicarrier systems are very sensitive to synchronization errors such as carrier frequency offset and phase noise. Synchronization errors cause loss of orthogonality among subcarriers and considerably degrade the performance especially when large number of subcarriers presents [4]–[5]. The MC-CDMA modulator is an effective technique for combating multipath fading over highly dispersive wireless channels. The problem encountered in digital communication is the synchronization between the transmitter and the receiver; there are many

obstacles in the channels. Reflections from these obstacles degrade the transmitted signal before it reaches the receiver. Hence, channel equalization is required to reduce the Bit Error Rate (BER) of the receiver as small as possible. In fact, the goal of the equalization techniques is to reduce the effect of the fading and the interference while not enhancing the effect of the noise on the decision of what data symbol was transmitted. Therefore, the problem of channel identification appears.

In this paper, authors propose an algorithm for blind channel identification, using higher order cumulants. There are several motivations behind this interest [6]. Firstly, higher order cumulants are blind to all kinds of Gaussian noise that is, the additive noise Gaussian will vanish in the higher order cumulants domain. Secondly, cumulants are useful in identifying non-minimum phase channels when the input is non-Gaussian and is contaminated by Gaussian noise.

The problem of the blind identification of the Broadband Radio Access Network (BRAN) channels, normalized by the European Telecommunications Standards Institute (ETSI) [7]–[8], and downlink MC-CDMA equalization using higher order cumulants was proposed by several authors [9]–[12].

In this contribution, authors present a partial combining equalizer for downlink MC-CDMA systems equalization, for that is in the one hand, the problem of the blind identification of (BRAN A) channel using the proposed algorithm is considered, and in the other hand the presented equalizer after the channel identification to correct the channel's distortion is used. The numerical simulation results, in noisy environment, are presented to illustrate the accuracy of the proposed algorithm, and the performance of equalization.

## 2. Channel Identification using Higher Order Cumulants

### 2.1. Channel Model

The term channel refers to the transmitting space (medium) between the transmitter and the receiver antennas as shown in Fig. 1.

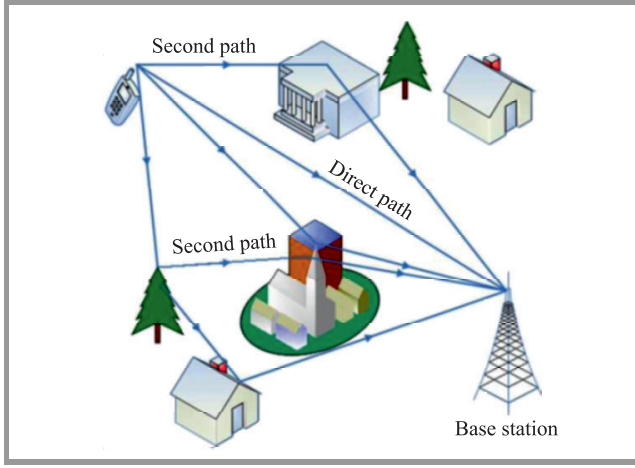

Fig. 1. Channel model.

The characteristics of wireless signal changes as it travels from the transmitter antenna to the receiver antenna. These characteristics depend upon the distance between the two antennas, the path(s) taken by the signal, and the environment (buildings and other objects) around the path. The profile of received signal can be obtained from that of the transmitted signal if we have a model of the medium between the two. This model of the medium is called channel model (Fig. 1).

In this paper it is assumed that the channel is time invariant and its impulse response is characterized by  $P$  paths of magnitudes  $\beta_p$  and phases  $\theta_p$ . The impulse response is given by:

$$h(\tau) = \sum_{p=0}^{P-1} \beta_p e^{j\theta_p} \delta(\tau - \tau_p). \quad (1)$$

In general, the received signal can be obtained by convolving the transmitted signal with the impulse response of the channel:

$$r(t) = h(t) * x(t) + n(t), \quad (2)$$

$$\begin{aligned} r(t) &= \int_{-\infty}^{+\infty} \sum_{p=0}^{P-1} \beta_p e^{j\theta_p} \delta(\tau - \tau_p) x(t - \tau) d\tau + n(t) = \\ &= \sum_{p=0}^{P-1} \beta_p e^{j\theta_p} x(t - \tau_p) + n(t), \end{aligned} \quad (3)$$

where  $x(t)$  is the input sequence,  $h(t)$  is the impulse response coefficients,  $\tau_p$  is the time delay of the  $p$ -th path, and  $n(t)$  is the additive noise sequence.

## 2.2. Moments and Cumulants

In this Subsection, a mathematical definitions of the estimated moments and cumulants needed to identifying the impulse response parameters of finite impulse response (FIR) systems are presented.

Let us consider a random non-Gaussian variable  $y(k)$ . The sample estimates are given by:

$$\widehat{M}_{m,y}(\tau_1, \dots, \tau_{m-1}) = \frac{1}{N} \sum_{i=1}^N y(i) y(i + \tau_1) \dots y(i + \tau_{m-1}). \quad (4)$$

As the cumulants are expressed in function of moments, the estimates cumulants of order two, three and four are defined respectively by:

$$\widehat{C}_{2,y}(\tau_1) = \widehat{M}_{2,y}(\tau_1) = \frac{1}{N} \sum_{i=1}^N y(i) y(i + \tau_1), \quad (5)$$

$$\begin{aligned} \widehat{C}_{3,y}(\tau_1, \tau_2) &= \widehat{M}_{3,y}(\tau_1, \tau_2) = \\ &= \frac{1}{N} \sum_{i=1}^N y(i) y(i + \tau_1) y(i + \tau_2), \end{aligned} \quad (6)$$

$$\begin{aligned} \widehat{C}_{4,y}(\tau_1, \tau_2, \tau_3) &= \widehat{M}_{4,y}(\tau_1, \tau_2, \tau_3) - \\ &- \widehat{M}_{2,y}(\tau_1) \widehat{M}_{2,y}(\tau_3 - \tau_2) - \\ &- \widehat{M}_{2,y}(\tau_2) \widehat{M}_{2,y}(\tau_3 - \tau_1) - \\ &- \widehat{M}_{2,y}(\tau_3) \widehat{M}_{2,y}(\tau_2 - \tau_1). \end{aligned} \quad (7)$$

## 2.3. Basic Relationships

In this section, the main general relationships between cumulants of the output signal and impulse response coefficients are described. The starting point for all algorithms based on higher order cumulants is Brillinger and Rosenblatt relation shows that the  $m$ -th order cumulants of  $y(k)$  can be expressed as a function of impulse response coefficients  $h(i)$  as follows [13]:

$$\begin{aligned} C_{m,y}(\tau_1, \tau_2, \dots, \tau_{m-1}) &= \\ &= \xi_{m,x} \sum_{i=0}^q h(i) h(i + \tau_1) \dots h(i + \tau_{m-1}), \end{aligned} \quad (8)$$

where  $\xi_{m,x}$  represents the  $m$ -th order cumulants of the excitation signal  $x(k)$  at origin.

Peyre *et al.* presents the relationship between different  $m$ -th and  $n$ -th order cumulants of the output signal,  $y(k)$ , and the coefficients  $h(i)$ , where  $n > m$  and  $(n, m) \in N^* - \{1\}$ , are linked by the following relationship [14]:

$$\begin{aligned} \sum_{j=0}^q h(j) C_{n,y}(j + \tau_1, j + \tau_2, \dots, j + \tau_{m-1}, \tau_m, \dots, \tau_{n-1}) &= \\ = \mu \sum_{i=0}^q h(i) \left[ \prod_{k=m}^{n-1} h(i + \tau_k) \right] C_{m,y}(i + \tau_1, i + \tau_2, \dots, i + \tau_{m-1}), \end{aligned} \quad (9)$$

where  $\mu = \frac{\xi_{n,x}}{\xi_{m,x}}$ .

In order to simplify the construction of the proposed algorithm we assume that:

- the input sequence,  $x(k)$ , is independent and identically distributed (i.i.d.) zero mean, and non-Gaussian;
- the system is causal and bounded, i.e.  $h(i) = 0$  for  $i < 0$  and  $i > q$ , where  $h(0) = 1$ ,
- the system order  $q$  is known,

- the measurement noise sequence  $n(k)$  is assumed zero mean, i.i.d., Gaussian and independent of  $x(k)$  with unknown variance.

The problem statement is to identify the parameters of the system  $h(i)_{(i=1,\dots,q)}$  using the cumulants of the measured output signal  $y(k)$ .

### 3. Proposed Algorithm

By substituting  $n = 4$  and  $m = 2$  into Eq. (9) the following equation can be obtained:

$$\begin{aligned} & \sum_{j=0}^q h(j)C_{4,y}(j + \tau_1, \tau_2, \tau_3) = \\ & = \mu \sum_{i=0}^q h(i) \left[ \prod_{k=2}^3 h(i + \tau_k) \right] C_{2,y}(i + \tau_1), \end{aligned} \quad (10)$$

$$\begin{aligned} & \sum_{j=0}^q h(j)C_{4,y}(j + \tau_1, \tau_2, \tau_3) = \\ & = \mu \sum_{i=0}^q h(i)h(i + \tau_2)h(i + \tau_3)C_{2,y}(i + \tau_1), \end{aligned} \quad (11)$$

where  $\mu = \frac{\xi_{4,x}}{\xi_{2,x}^2}$ .

The autocorrelation function of the (FIR) systems vanishes for all values of  $|\tau| > q$ , equivalently:

$$C_{2,y}(\tau) = \begin{cases} \neq 0, & |\tau| \leq q; \\ 0 & \text{otherwise.} \end{cases}$$

If we suppose that  $\tau_1 = q$  the Eq. (11) becomes:

$$\sum_{j=0}^q h(j)C_{4,y}(j + q, \tau_2, \tau_3) = \mu h(0)h(\tau_2)h(\tau_3)C_{2,y}(q), \quad (12)$$

and for  $\tau_3 = 0$  the Eq. (12) becomes:

$$\sum_{j=0}^q h(j)C_{4,y}(j + q, \tau_2, 0) = \mu h^2(0)h(\tau_2)C_{2,y}(q). \quad (13)$$

The considered system is causal and bounded, thus, the interval of the  $\tau_2$  is  $\tau_2 = 0, \dots, q$ .

Else if we suppose that  $\tau_2 = 0$ , and using the cumulants properties  $C_{m,y}(\tau_1, \tau_2, \dots, \tau_{m-1}) = 0$ , if one of the variables  $\tau_k > q$ , where  $k = 1, \dots, m - 1$ , the Eq. (13) becomes:

$$C_{4,y}(q, 0, 0) = \mu h^3(0)C_{2,y}(q). \quad (14)$$

Thus, we are based on Eq. (14) for eliminating  $C_{2,y}(q)$  in Eq. (13), we obtain the equation constituted of only the fourth order cumulants, this equation describe the proposed algorithm:

$$\sum_{j=0}^q h(j)C_{4,y}(j + q, \tau_2, 0) = h(\tau_2)C_{4,y}(q, 0, 0). \quad (15)$$

The system of Eq. (15) can be written in matrix form as:

$$\begin{bmatrix} C_{4,y}(q+1, 0, 0) & \dots & C_{4,y}(2q, 0, 0) \\ C_{4,y}(q+1, 1) - \alpha & \dots & C_{4,y}(2q, 1, 0) \\ \vdots & \ddots & \vdots \\ C_{4,y}(q+1, q, 0) & \dots & C_{4,y}(2q, q, 0) - \alpha \end{bmatrix} \times \begin{bmatrix} h(1) \\ \vdots \\ h(i) \\ \vdots \\ h(q) \end{bmatrix} = \begin{bmatrix} 0 \\ -C_{4,y}(q, 1, 0) \\ \vdots \\ -C_{4,y}(q, q, 0) \end{bmatrix}, \quad (16)$$

where  $\alpha = C_{4,y}(q, 0, 0)$ . Or, in more compact form, the Eq. (16) can be written as follows:

$$Mh_e = d, \quad (17)$$

where  $M$  is the matrix of size  $(q+1) \times (q)$  elements,  $h_e$  is a column vector constituted by the unknown impulse response parameters  $h(i)_{i=1,\dots,q}$  and  $d$  is a column vector of size  $(q+1)$  as indicated in the Eq. (16). The least squares solution of the system of Eq. (17), permits blindly identification of the parameters  $h(i)$  and without any information of the input selective channel. Thus, the solution will be written under the following form:

$$\hat{h}_e = (M^T M)^{-1} M^T d. \quad (18)$$

### 4. MC-CDMA Model

The multicarrier code division multiple access (MC-CDMA) system is based on the combination of code division multiple access (CDMA) and orthogonal frequency division multiplexing (OFDM), which is potentially robust to channel frequency selectivity. However, the complex symbol  $a_i$  of each user  $i$  is, firstly, multiplied by each chip  $c_{i,k}$  of spreading code, and then applied to the modulator

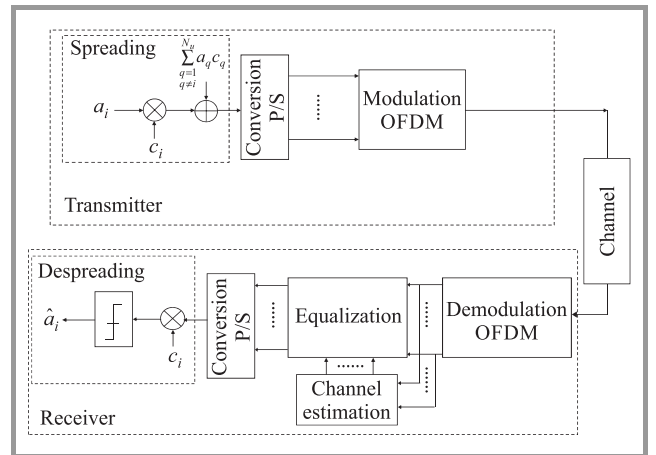

Fig. 2. MC-CDMA modulator principle.

of multicarriers. Each subcarrier transmits an element of information multiply by a code chip of that subcarrier. Figure 2 explains the principle of the MC-CDMA systems.

#### 4.1. MC-CDMA Transmitter

The MC-CDMA signal is given by:

$$x(t) = \frac{a_i}{\sqrt{N_p}} \sum_{k=0}^{N_p-1} c_{i,k} e^{2j\pi f_k t}, \quad (19)$$

where  $f_k = f_0 + \frac{k}{T_c}$ ,  $N_p$  is the number of subcarriers, and we consider  $L_c = N_p$ .

#### 4.2. MC-CDMA Receiver

The downlink received MC-CDMA signal at the input receiver is given by the following equation:

$$r(t) = \frac{1}{\sqrt{N_p}} \sum_{p=0}^{P-1} \sum_{k=0}^{N_p-1} \sum_{i=0}^{N_u-1} \times \Re \left\{ \beta_p e^{j\theta_p} a_i c_{i,k} e^{2j\pi(f_0+k/T_c)(t-\tau_p)} \right\} + n(t) \quad (20)$$

The Eq. (20) can be written as follows:

$$r = HCa + n, \quad (21)$$

where  $r$  denotes a vector composed of the values received on each subcarrier:

$$r = [r_0, \dots, r_{N_p-1}]^T. \quad (22)$$

The matrix  $H$  represents the matrix of complex coefficients of channel with size  $N_p \times N_p$ :

$$H = \begin{bmatrix} h_0 & 0 & \dots & 0 \\ 0 & h_1 & \dots & 0 \\ \cdot & \cdot & \cdot & \cdot \\ \cdot & \cdot & \cdot & \cdot \\ 0 & 0 & \dots & h_{N_p-1} \end{bmatrix}. \quad (23)$$

The matrix  $C$  represent the spreading codes:

$$C = \begin{bmatrix} c_{0,0} & c_{0,1} & \dots & c_{0,N_u-1} \\ c_{1,0} & c_{1,1} & \dots & c_{1,N_u-1} \\ \cdot & \cdot & \cdot & \cdot \\ \cdot & \cdot & \cdot & \cdot \\ c_{L_c-1,0} & c_{L_c-1,1} & \dots & c_{L_c-1,N_u-1} \end{bmatrix}, \quad (24)$$

where

$$\begin{aligned} c_i &= [c_{0,i}, c_{1,i}, \dots, c_{L_c-1,i}]^T, \\ a &= [a_0, \dots, a_{N_u-1}]^T, \\ n &= [n_0, \dots, n_{N_p-1}]^T. \end{aligned} \quad (25)$$

At the reception, we demodulate the signal according the  $N_p$  subcarriers, and then we multiply the received sequence by the code of the user. Figure 3 explains the single user detection principle. Using the above matrix notation, it is

possible to express  $G$  – the diagonal matrix composed of the coefficients  $g_k$  equalization:

$$G = \begin{bmatrix} g_0 & 0 & \dots & 0 \\ 0 & g_1 & \dots & 0 \\ \cdot & \cdot & \cdot & \cdot \\ \cdot & \cdot & \cdot & \cdot \\ 0 & 0 & \dots & g_{N_p-1} \end{bmatrix}. \quad (26)$$



Fig. 3. Principle of the single user-detection.

After the equalization and the spreading operation, the estimation  $\hat{a}_i$  of the emitted user symbol  $a_i$ , of the  $i$ -th user can be written by the following equations:

$$\begin{aligned} \hat{a}_i &= c_i^T Gr \\ &= c_i^T G(HCa + n) \\ &= c_i^T GHCa + c_i^T Gn. \end{aligned} \quad (27)$$

$$\begin{aligned} \hat{a}_i &= \sum_{q=0}^{N_u-1} \sum_{k=0}^{N_p-1} c_{i,k} (g_k h_k c_{q,k} a_q + g_k n_k) = \\ &= \underbrace{\sum_{k=0}^{N_p-1} c_{i,k}^2 g_k h_k a_i}_{\text{I (i=q)}} + \underbrace{\sum_{q=0}^{N_u-1} \sum_{k=0}^{N_p-1} c_{i,k} c_{q,k} g_k h_k a_q}_{\text{II (i≠q)}} + \\ &+ \underbrace{\sum_{k=0}^{N_p-1} c_{i,k} g_k n_k}_{\text{III}} \end{aligned} \quad (28)$$

where the term I, II and III of Eq. (28) are, respectively, the signal of the considered user, a signals of the others users (multiple access interferences) and the noise pondered by the equalization coefficient and by spreading code of the chip.

If we suppose that the spreading code are orthogonal, i.e.

$$\sum_{k=0}^{N_p-1} c_{i,k} c_{q,k} = 0 \quad \forall i \neq q, \quad (29)$$

Eq. (28) will become:

$$\hat{a}_i = \underbrace{\sum_{k=0}^{N_p-1} c_{i,k}^2 g_k h_k a_i}_{\text{I (i=q)}} + \underbrace{\sum_{k=0}^{N_p-1} c_{i,k} g_k n_k}_{\text{III}}. \quad (30)$$

## 5. Partial Combining Equalizer

In [15] a partial combining (PC) technique was introduced, with coefficient  $g_k$  function of a PC parameter,  $-1 \leq \beta \leq 1$ , as given by:

$$g_k = \frac{h_k^*}{|h_k|^{1+\beta}}. \quad (31)$$

The estimated received symbol,  $\hat{a}_i$  of symbol  $a_i$  of the user  $i$  is described by:

$$\hat{a}_i = \sum_{k=0}^{N_p-1} c_{i,k}^2 \frac{|h_k|^2}{|h_k|^{1+\beta}} a_i + \sum_{k=0}^{N_p-1} c_{i,k} \frac{h_k^*}{|h_k|^{1+\beta}} n_k. \quad (32)$$

**5.1. Particular Case:  $\beta = 1$  – Zero Forcing Equalizer**

The gain factor of the zero forcing (ZF) equalizer, is given by the equation:

$$g_k = \frac{1}{h_k}. \quad (33)$$

The estimated received symbol,  $\hat{a}_i$  of symbol  $a_i$  of the user  $i$  is described by:

$$\hat{a}_i = \sum_{k=0}^{N_p-1} c_{i,k}^2 a_i + \sum_{k=0}^{N_p-1} c_{i,k} \frac{1}{h_k} n_k. \quad (34)$$

**6. Simulation Results**

In this section the numerical results for blind identification and equalization in MC-CDMA systems are presented. For that we consider the BRAN A model representing the propagation in an indoor case. The Eq. (35) describe the impulse response of BRAN A channel:

$$h(\tau) = \sum_{i=0}^{N_T} A_i \delta(\tau - \tau_i). \quad (35)$$

In the Table 1 the measured values corresponding the BRAN A radio channel impulse response are summarized.

Table 1

Delay and magnitudes of 18 targets of BRAN A channel

Delay $\tau_i$ [ns]	Mag. $A_i$ [dB]	Delay $\tau_i$ [ns]	Mag. $A_i$ [dB]
0	0	90	-7.8
10	-0.9	110	-4.7
20	-1.7	140	-7.3
30	-2.6	170	-9.9
40	-3.5	200	-12.5
50	-4.3	240	-13.7
60	-5.2	290	-18
70	-6.1	340	-22.4
80	-6.9	390	-26.7

Although, the BRAN A channel is constituted by  $N_T = 18$  parameters and seeing that the latest parameters are very small, for that we have taking the following procedure:

- the BRAN A channel impulse response is decomposed into three subchannels:

$$h(i) = \sum_{j=1}^3 h_j(i); \quad (36)$$

- the parameters of each subchannel are estimated independently, using the proposed algorithm;

- all subchannel parameters are added, to construct the full BRAN A channel impulse response.

The simulation is performed with Matlab software and for different SNR.

**6.1. Identification of BRAN A Channel using the Proposed Algorithm**

In this subsection the BRAN A channel model is considered. Figure 4 show the impulse response estimation for this channel using the proposed algorithm for different SNR and an data length  $N = 5400$ .

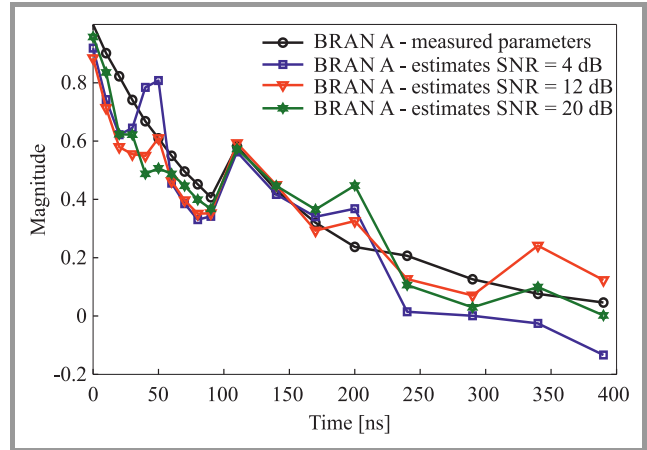

Fig. 4. Estimated of the BRAN A channel impulse response, for different SNR and a data length  $N = 5400$ .

This figure shows clearly the influence of Gaussian noise on parameter estimation of the BRAN A impulse response. This influence is clear principally for the last five values, where the estimated parameters do not follow those measured. But, before the last fifth values, the 13th first estimated values are closed to those measured are observed. This due that the additive Gaussian noise vanished in the higher order cumulants domain.

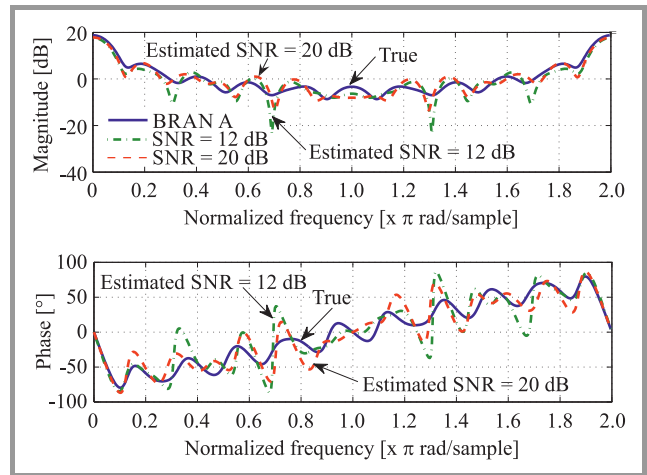

Fig. 5. Estimated of the BRAN A channel impulse response using all target, for different SNR and a data length  $N = 5400$ .

### 6.2. Magnitude and Phase Estimation of BRAN A Channel using the Proposed Algorithm

In Fig. 5 we represent the estimation magnitude and phase of the impulse response of the BRAN A channel using the proposed algorithm, for an SNR varying between 12 dB and 20 dB, the data length is 5400.

The estimated magnitude and phase have the same form. In the fact, one can see a low influence of the noise on the estimation of the magnitude and phase principally when the noise is  $SNR > 12$  dB, and we have not more difference between the estimated and the true ones.

### 6.3. Compensation of Fading Channels using Partial Combining Equalizer

In order to evaluate the performance of the MC-CDMA system, using the presented equalizer. These performances are evaluated by calculation of the BER, for different values of  $\beta$ , using the measured and estimated, using proposed algorithm of the BRAN A channel impulse response.

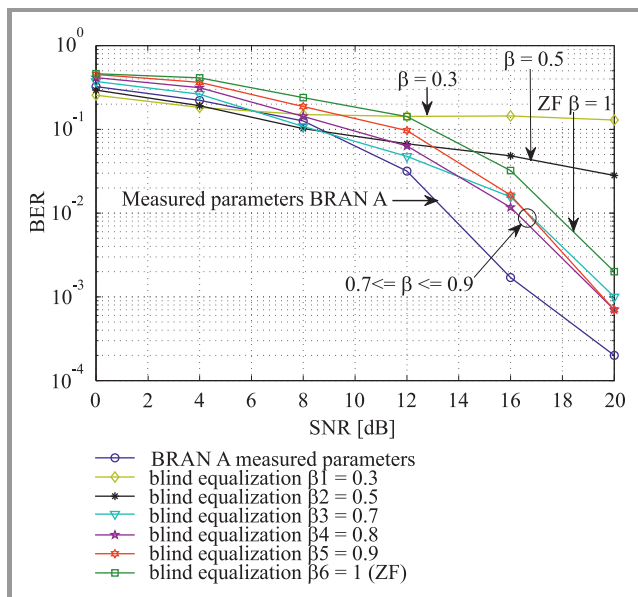

Fig. 6. BER of the estimated and measured BRAN A channel, for different SNR, using the presented equalizers.

Figure 6 shows the simulation results of BER estimation, for different SNR, using presented equalizer of the BRAN A channel impulse response when  $0.7 \leq \beta \leq 0.9$  the partial combining equalizer is more precise and gives good results than those obtained by ZF equalizer. Also, the ZF equalizer is best compared to the results obtained using partial combining equalizer for  $\beta \leq 0.6$ .

## 7. Conclusion

In this contribution, a partial combining equalizer has been analytically and numerically investigated in MC-CDMA systems. In the part of the channel identification, the BRAN

A model was used representing the propagation in an indoor case normalized for MC-CDMA systems. To estimate the coefficients of this equalizer, the authors have proposed an algorithm based on fourth order cumulants. The proposed algorithm shows their efficiency in the impulse response channel identification with very good precision. In the part of the equalization for the MC-CDMA systems using the presented equalizer, it has been demonstrated that the partial combining equalizer is very adequate for correcting the channel distortion for  $0.7 \leq \beta \leq 0.9$ .

## References

- [1] Z. Wang and G. B. Giannakis, "Wireless multicarrier communications: where Fourier meets Shannon", *IEEE Sig. Process. Mag.*, vol. 17, no. 3, pp. 29–48, 2000.
- [2] S. Hara and R. Prasad, "Overview of multicarrier CDMA", *IEEE Commun. Mag.*, vol. 35, pp. 126–133, 1997.
- [3] N. Yee, J.-P. M. G. Linnartz, and G. Fettweis, "Multi-Carrier-CDMA in indoor wireless networks", in *Proc. 4th Int. Symp. on Personal, Indoor and Mob. Radio Commun. PIMRC'93*, Yokohama, Japan, 1993, pp. 109–113.
- [4] M. Frikel, B. Targui, F. Hamon, and M. M'Saad, "Adaptive equalization using controlled equal gain combining for uplink/downlink MC-CDMA systems", *Int. J. of Signal Process.*, vol. 4, no. 3, pp. 230–237, 2008.
- [5] M. Frikel, S. Safi, B. Targui, and M. M'Saad, "Channel Identification using chaos for an uplink/downlink multicarrier code division multiple access system", *J. Telecommun. and Inform. Technol.*, no. 1, pp. 48–54, 2010.
- [6] M. Boulouird and M. M'Rabet Hassani, "Blind identification of MA models using cumulants", *Int. J. of Electrical, Electronic Sci. & Engin.*, vol. 1, no. 6, pp. 619–623, 2007.
- [7] ETSI, "Broadband Radio Access Networks (BRAN); High Performance Radio Logical Area Network (HIPERLAN) Type 2; Requirements and architectures for wireless broadband access", Jan. 1999.
- [8] ETSI, "Broadband Radio Access Networks (BRAN); HIPERLAN Type 2; Physical Layer", Dec. 2001.
- [9] M. Zidane, S. Safi, M. Sabri, A. Boumezzough, and M. Frikel, "Broadband radio access network channel identification and downlink MC-CDMA equalization", *Int. J. of Energy, Inform. and Commun.*, vol. 5, no. 2, pp. 13–34, 2014.
- [10] M. Zidane, S. Safi, M. Sabri, and A. Boumezzough, "Blind Identification Channel Using Higher Order Cumulants with Application to Equalization for MC-CDMA System", *Int. J. of Elec., Robot., Electron. and Commun. Engin.*, vol. 8, no. 2, pp. 369–375, 2014.
- [11] S. Safi, M. Frikel, A. Zeroual, and M. M'Saad, "Higher order cumulants for identification and equalization of multicarrier spreading spectrum systems", *J. of Telecommun. and Inform. Technol.*, no. 1, pp. 74–84, 2011.
- [12] M. Zidane, S. Safi, M. Sabri, A. Boumezzough, and M. Frikel, "Adaptive algorithms versus higher order cumulants for identification and equalization of MC-CDMA", *J. of Telecom. & Inform. Technol.*, no. 3, pp. 53–62, 2014.
- [13] D. Brillinger and M. Rosenblatt, "Computation and interpretation of  $k$ -th order spectra", in *Spectral Analysis of Time Signals*, B. Harris, Ed. New York: Wiley, 1967, pp. 189–232.
- [14] J. L. Peyre, D. Dembélé, and G. Favier, "Identification of MA models using higher order statistics: A general formulation", in *Proc. 2nd ATHOS Worksh. on System Identif. and Higher Order Statist.*, Sophia-Antipolis, France, 1993, pp. 20–21.
- [15] A. Conti, "MC-CDMA bit error probability and outage minimization through partial combining", *IEEE Commun. Lett.*, vol. 9, no. 12, pp. 1055–1057, 2005.

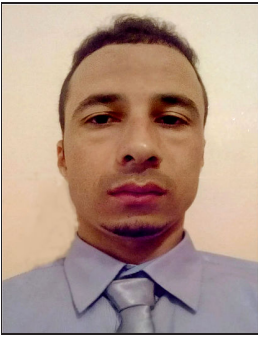

**Mohammed Zidane** received the M.Sc. in Electronic Engineering from Sultan Moulay Slimane University, Beni Mellal, Morocco, and M.Sc. in Optoelectronics and Laser Instrumentation from Faculty of Science and Techniques Hassan first University, Settat, Morocco. He has Ph.D. in Digital Telecommunications and Signal

Processing from Sultan Moulay Slimane University, Beni Mellal, Morocco. His research interest includes digital communications and signal processing, linear and non-linear Broadband Radio Access Network (BRAN) channels identification, higher order statistics, blind identification and equalization in MC-CDMA systems, subjects on which he has published 8 journal papers and 4 conference papers.

E-mail: zidane.ilco@gmail.com  
 Department of Physics  
 Faculty of Sciences and Techniques  
 Sultan Moulay Slimane University  
 PO box 523, Beni Mellal, Morocco



**Said Safi** received the B.Sc. degree in Physics from Cadi Ayyad University, Marrakech, Morocco, in 1995, M.Sc. and Ph.D. degrees from Chouaib Doukkali University and Cadi Ayyad University, Morocco, in 1997 and 2002, respectively. He has been a professor of information theory and telecommunication systems at the Na-

tional School for Applied Sciences, Tangier Morocco, from 2003 to 2005. Since 2006, he is a professor of applied mathematics and programming at the Faculty of Science and Technic, Beni Mellal Morocco. In 2008 he received the Ph.D. degree in telecommunication and informatics from the Cadi Ayyad University. His general interests span the areas of communications and signal processing, estimation, time-series analysis, and system identification-subjects on which he has published 10 journal papers and more than 40 conference papers. Current research topics focus on transmitter and receiver diversity techniques for single- and multi-user fading communication channels, and wide-band wireless communication systems.

E-mail: safi.said@gmail.com  
 Department of Mathematic and Informatic  
 Polydisciplinary Faculty  
 Sultan Moulay Slimane University  
 PO box 592, Beni Mellal, Morocco

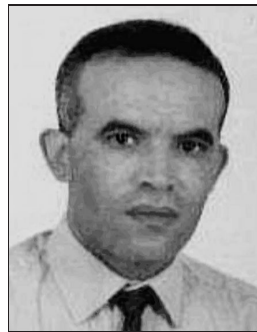

**Mohamed Sabri** received the Ph.D. degree in Signal Processing and Telecommunications, from Rennes I University, France. His current research interests are communication networks evolution and human face detection and recognition. He is currently working as a Professor in Department of Physics, Faculty of Sciences and Techniques, University of Sultan Moulay Slimane, Beni Mellal, Morocco.

E-mail: sipt03@yahoo.fr  
 Department of Physics  
 Faculty of Sciences and Techniques  
 Sultan Moulay Slimane University  
 PO box 523 Beni Mellal, Morocco