

Differentiated Service Model-Supported Cluster-Based Routing in Wireless Sensor Networks

Jayashree Agarkhed¹, Patil Yogita Dattatraya², and Siddarama Patil³

¹ Department of CSE, P.D.A College of Engineering, Kalaburagi, India

² Department of CSE, Sharnbasva University, Kalaburagi, India

³ Department of E&CE, P.D.A College of Engineering, Kalaburagi, India

<https://doi.org/10.26636/jtit.2020.139119>

Abstract—Wireless Sensor Network finds its extensive use in healthcare applications for the transfer of time-critical data through wireless connectivity. The primary cause of network failure is the transfer of time-critical multimedia data. The article presents a new differentiated service model-supported (DSM) cluster-based routing in wireless sensor networks (WSNs) that overcomes the above issue. DSM prioritizes the transfer of different flow types based on packet type and packet size. The employment of computational offloading minimizes delay for critical and small-sized data packets and by carrying out data reduction of large-sized packets at proxy server. It outperforms the existing protocols in terms of energy efficiency, throughput, and reliability by prioritizing the transfer of time-critical health application data.

Keywords—clustering, energy efficiency, proxy server, TDMA, wireless sensor networks.

1. Introduction

A Wireless Sensor Network (WSN) consists of a group of randomly deployed sensor nodes that are capable of detecting various environmental phenomena, such as air pressure, temperature, humidity, etc. It sends the data collected to the base station referred to as the sink [1]. Different topologies are used as far as connectivity between the nodes is concerned, e.g. star, mesh and tree-shaped. Among the three, tree-based routing is the best solution for node communication. A mesh network incurs a routing overhead and requires the provision of a routing table. Compared to the star-based topology, tree-based routing protocols are characterized by lower energy consumption, as they rely on multi-hop communication.

Several techniques exist for minimizing energy consumption and increasing network lifetime [2], [3] by relying on energy-harvesting [4]–[9]. Power consumption is minimized by duty cycling [10]–[12] and data reduction techniques. In this work, a differentiated service model-supported cluster-based routing in WSN (DSM) is presented [12]. It provides a reliable and energy efficient method for transferring data from a sensor node to the

cluster head (CH), using an adaptable path that is based on packet data type. DSM prioritizes the forwarding of time-critical data along one primary routing path through queue 1. A reduction in data quantity at the sensor node is based on computation time. Small size packets are used to reduce the amount of data at the sensor node, and are passed through queue 2, while the large size packets are passed through queue 3 and are subjected to data reduction techniques later, at the proxy server. The packets compressed at the sensor node are passed through queue 2. The uncompressed packets are passed through queue 3, and emergency packets are passed through a queue 1 to support service differentiation.

Further, these packets are transmitted simultaneously, which results in the bandwidth of all paths being aggregated to achieve high throughput and reduced delay. By the use of different traffic flows for different service classes, interference between different packet types is avoided. A Local Energy Consumption Prediction-based clustering protocol for Wireless Sensor Networks (LECP) [14] lack this feature and packets flowing through the same path are subject to high interference and delay leading to retransmission of lost packets. The DSM is an extension of Energy efficient service differentiated QoS aware routing in cluster-based wireless sensor network [13] with simulation graph obtained by a varying number of nodes, interval, and simulation time. The remaining sections of this paper are organized as follows. Section 2 presents details concerning the related work, and Section 3 presents the proposed technique. Section 4 lists the simulation parameters with performance evaluation, and Section 5 concludes the work.

2. Related Work

In [15], the author points out that WSN nodes rely on a limited capacity of the power source, restricted communication bandwidth, processing speed and memory space. These limitations have given rise to numerous research projects and studies which focused exclusively on maximizing the utilization of the limited sensor resources [16].

Efficient use of power during data transmission is achieved by adopting an approach known as clustering. Clustering helps improve network scalability, load balancing, and allows to reduce the size of the routing table at individual nodes [17], [18] in order to save the communication bandwidth by relying on inter-cluster interaction among CHs [19]. It is also useful for providing a stabilized network topology [20]. To conserve energy, CH may schedule cluster activities by switching a given node to active and sleep modes [21], [22]. The following is another advantage of clustering: CH aggregate data from all sensors in their respective clusters to reduce the count of packets to be sent [23]. In [24], the author proposed non real-time and real-time traffic transmission solutions based on the initial energy of sensor nodes derived from different energy levels, inverse expected transmission count, expected transmission count, and minimum loss. In papers [25], [26], an incremental approach to a given session, in which high bandwidth is required to satisfy the needs of multimedia applications, is proposed by relying on non-interfering paths in order to support an increased lifetime of each node. In [26], the author discussed a routing protocol related to healthcare and the need of using the multipath approach in order to achieve an optimal solution to satisfy the QoS requirement of the critical application. Based on the study of related work, one may identify one crucial aspect that need to be met: QoS parameters, such as data accuracy, minimized delay and minimized energy consumption, need to be optimized in order to improve the lifetime of a sensor node.

3. Proposed Technique

The proposed technique begins with cluster formation and the complete operation specified in terms of rounds. The clustered topology formed by dividing the cluster setup phase into sub-phases is presented in Fig. 1. The first sub-phase consists in network initialization and in predicting energy consumption. The CH selection sub-phase occurs next and, finally, cluster formation takes place, followed by route construction.

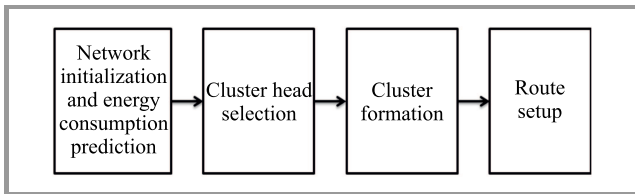

Fig. 1. Cluster formation and route setup.

Each node first broadcasts a Node_Msg containing the ID and current energy within radius Ra . The node also accepts the Node_Msgs sent by its neighbors. Upon receiving this information, each node computes the distance to each of its neighbors based on the strength of the received signal, i.e. Received Signal Strength Indication (RSSI). Then

RSSI value is used to compute the energy consumption ratio E_{ratio} used to select the CH. For any node N_i , its E_{ratio} computed in time interval T_1 is:

$$E_{ratio}(N_i) = \sum_{i=1}^n \frac{E_{con}(N_i)}{E_{cur}(N_i)}, \quad (1)$$

where E_{con} – energy consumed by node i , E_{cur} – current energy of node i , n – number of sensor nodes within the range of node N_i .

The node with the lowest energy consumption ratio is selected as CH.

CH selection commences after time interval T_1 . Each node compares its energy consumption ratio with that of other nodes and the node with the lowest E_{ratio} is selected as being capable of assuming the role of CH. If the node does not receive the Head_Msg after time interval T_2 , then it broadcasts the Head_Msg within radius Ra to announce itself as CH and prepares to receive the Join_Msg to create a TDMA schedule for all CM within range Ra . If the node receives the Head_Msg, then it sends the Join_Msg and waits to receive a TDMA schedule.

If a node is not selected as CH, then it finds the nearest CH and sends the Join_Msg to that CH. The Join_Msg contains the ID of the node and its current energy. Then, in each cluster, CH creates a TDMA schedule based on the Join_Msgs received and broadcasts the TDMA schedule to all CMs. After the end of this round, the data transmission phase occurs.

3.1. Route Setup

The proposed cluster-based approach employs two types of communication: direct and intra-cluster communication.

In intra-cluster routing, every CM node collects data periodically from the environment and checks the data stream type. Packets with a small data size are compressed and sent to CH. Then, CH classifies the data packet as an emergency data packet, a compressed data packet or an uncompressed data packet. The collected data are sent, within a given time slot, to the CH based on the TDMA schedule. The transmission of data within a given time slot allows to avoid packet collision and retransmission in the same cluster. Upon collecting data from CMs, the CH aggregates the data and performs data transmission based on a routing tree, along a path that satisfies inter-cluster routing.

For inter-cluster communication, a routing tree is created between the CHs within time T . Each CH broadcasts a route request. CH i chooses its next-hop node as a base station if its distance to the base station is lower than Euclidean distance. Else, it chooses node j , having a minimum distance to the base station and a minimum E_{ratio} among all its neighboring CH nodes (Figs. 2 to 5).

As depicted in Fig. 2, the N2 is the source node, while N1, N3, and N5 are chosen as candidate nodes for the next-hop based on their distance to the nearest BS. The subsequent node with the lowest energy consumption ratio is chosen as a next-hop. Finally, N5 has the lowest E_{ratio} among N1,

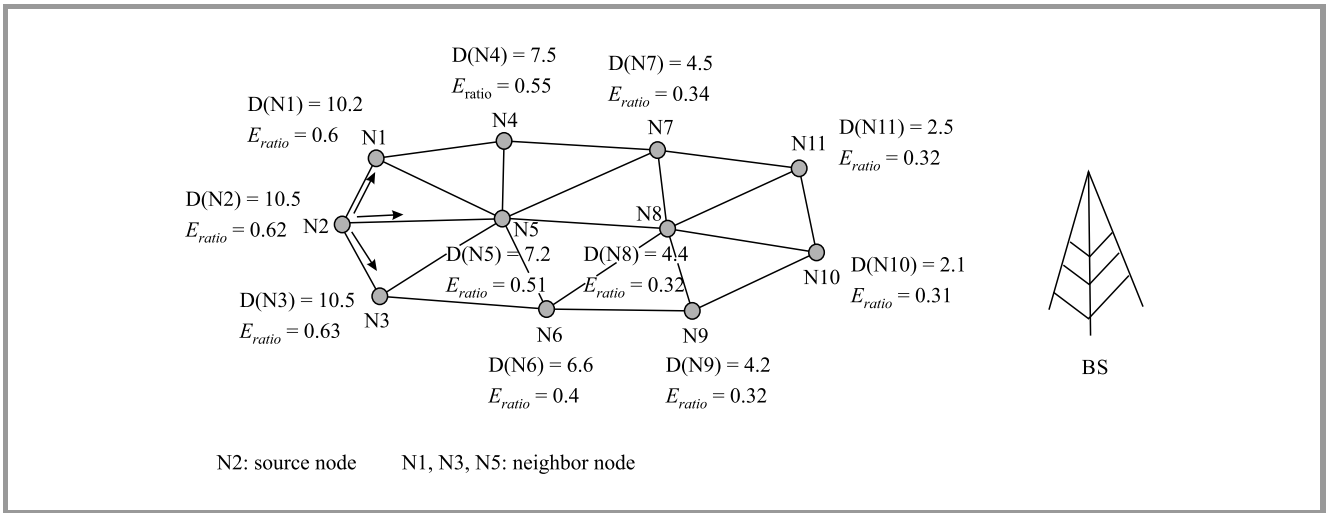

Fig. 2. Choosing candidate nodes from the N2 node.

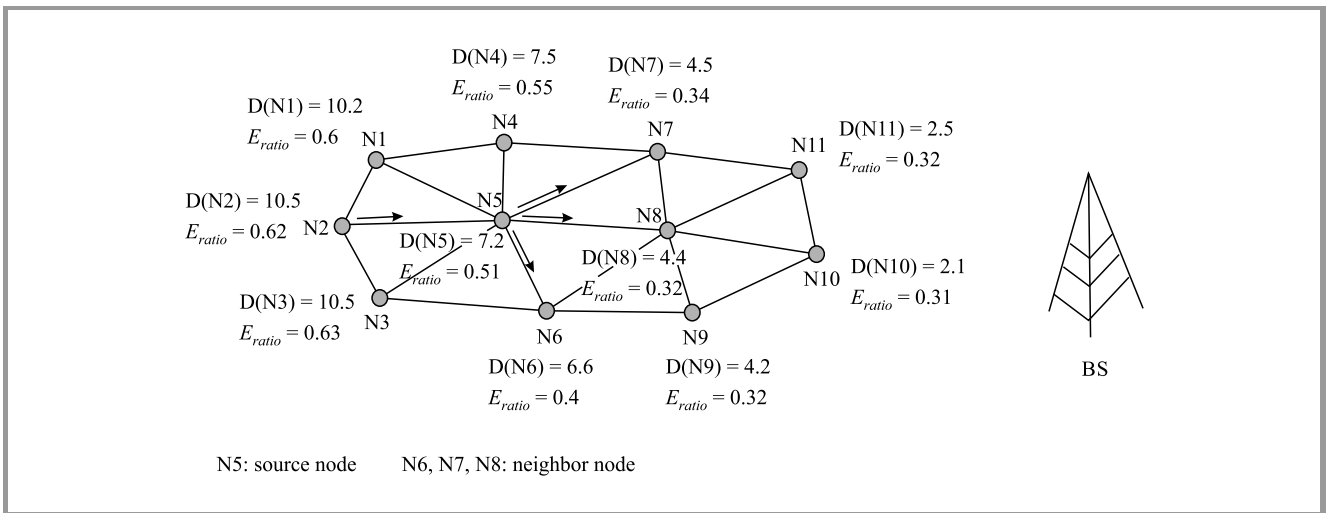

Fig. 3. Choosing candidate nodes from the N5 node.

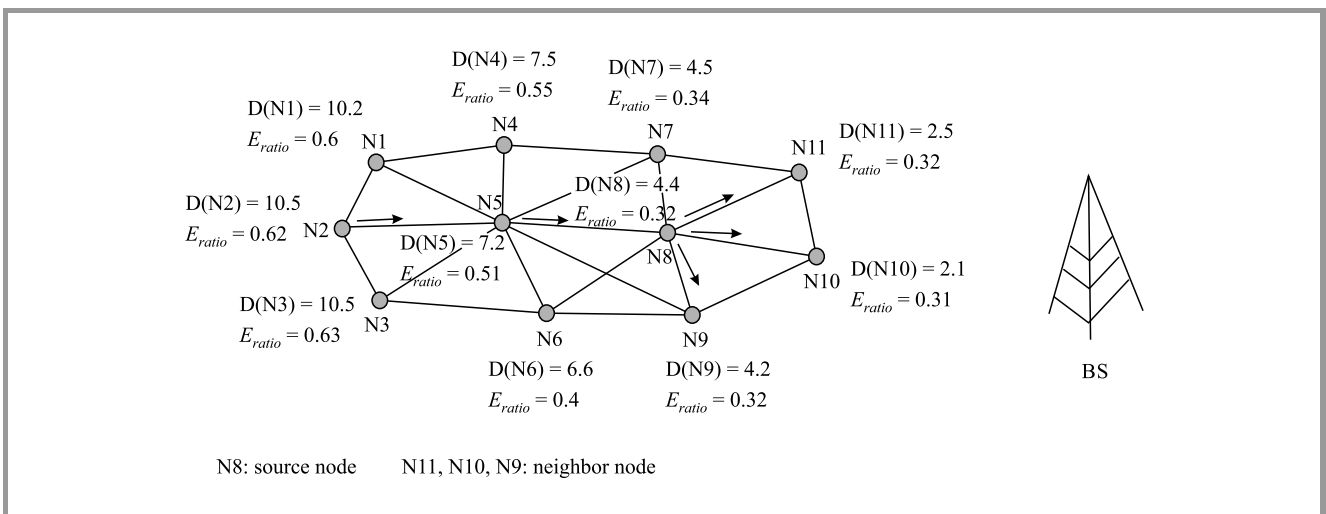

Fig. 4. Choosing candidate nodes from the N8 node to BS.

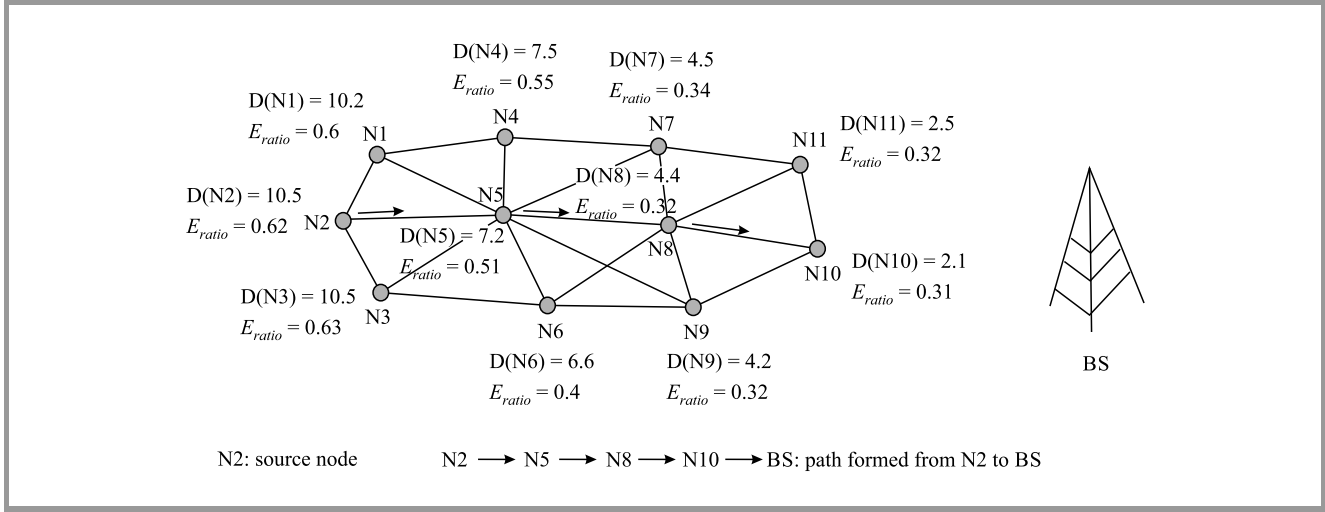

Fig. 5. Path established from node N2 to BS.

N3, and N5 nodes and is selected as the next-hop within the tree.

As shown in Fig. 3, N5 is the source node, while nodes N6, N7, and N8 are chosen as candidate nodes for the next-hop based on their distance to the nearest BS. The subsequent node with the lowest energy consumption ratio E_{ratio} is selected as the next-hop. The N8 has the lowest E_{ratio} value among N6, N7, and N8 nodes and is selected as the next-hop within the tree.

As depicted in Fig. 4, the N8 is the source node, while nodes N9, N10, and N11 are chosen as candidate nodes for the next-hop based on their distance to the nearest BS. The subsequent node with the lowest energy consumption ratio is selected as the next-hop. Node N10 has the lowest value among the N9, N10, and N11 and is chosen as the next-hop node. Finally, the path is constructed from source node N2 to the sink through intermediate N5, N8, N10 nodes, as depicted (Fig. 5).

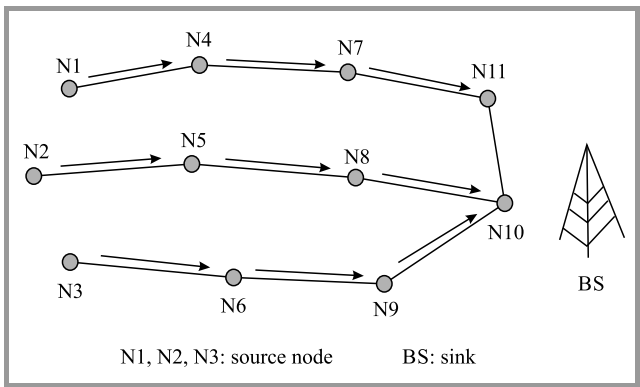

Fig. 6. Path constructions from node N1, N2, and N3 to BS.

Figure 5 shows the path from source node N2 to the sink node, through intermediate nodes N5, N8, N10, while Fig. 6 shows a routing path from nodes N1, N2, and N3 to BS.

Algorithm 1: DSM

Input: Packet with the different data stream

Output: Prioritized packets directed on different paths

1. Deploy heterogeneous sensor nodes
2. Base station broadcast hello packets to all nodes
3. Node local energy consumption calculation
 - 3.1. Calculate nodes present energy:

$$E_{pr} = E_{ini} - E_{tr} , \tag{2}$$

where E_{pr} – node present energy, E_{ini} – node initial energy, E_{tr} – energy consumption for data transmission

- 3.2. Update nodes information
 - 3.2.1. Store BS location
 - 3.2.2. Acknowledge BS with node location, node type, and neighbor list
4. Select CH as a node with maximum present energy and remaining nodes as cluster members
5. Schedule nodes within the cluster using TDMA
6. Calculate energy consumed at the sensor for data reduction

$$E_{sn} = P_{sn} \cdot \frac{T_c}{S_{sn}} , \tag{3}$$

where E_{sn} – energy consumed at sensor node, P_{sn} – power consumed by sensor node, T_c – total computation, S_{sn} – speed of sensor

7. Calculate power consumed at proxy server for data reduction

$$E_{ps} = P_{td} \cdot \frac{D_t}{B} + W_p \cdot \frac{T_c}{S_{ps}} , \tag{4}$$

where E_{ps} – power consumed at the proxy server, $\frac{D_t}{B}$ – energy consumed to transmit data D_t , to proxy in given bandwidth B , P_{td} – data transmission power, W_p – power spent by server waiting for data, S_{ps} – proxy server speed

8. **If** $E_{sn} < E_{ps}$ **then** perform data reduction at sensor node and send packet on a different path
Else perform data reduction at the proxy server and send the packet on a different path
9. Data transmission from the sensor node to CH and from CH to BS
10. Performance evaluation
11. End

3.2. DSM Algorithm

The proposed protocol relies on clustering to reduce transmission energy, using the inter-cluster communication routing tree construction algorithm, based on the local energy consumption ratio of nodes [26], and also provides differentiated service as illustrated in Algorithm 1.

Energy consumption, delay, and overall routing overheads have been minimized and throughput has been increased by DSM, as shown in simulation graphs, due to its efficient cluster setup and routing tree construction, as depicted in Figs. 7 and 8.

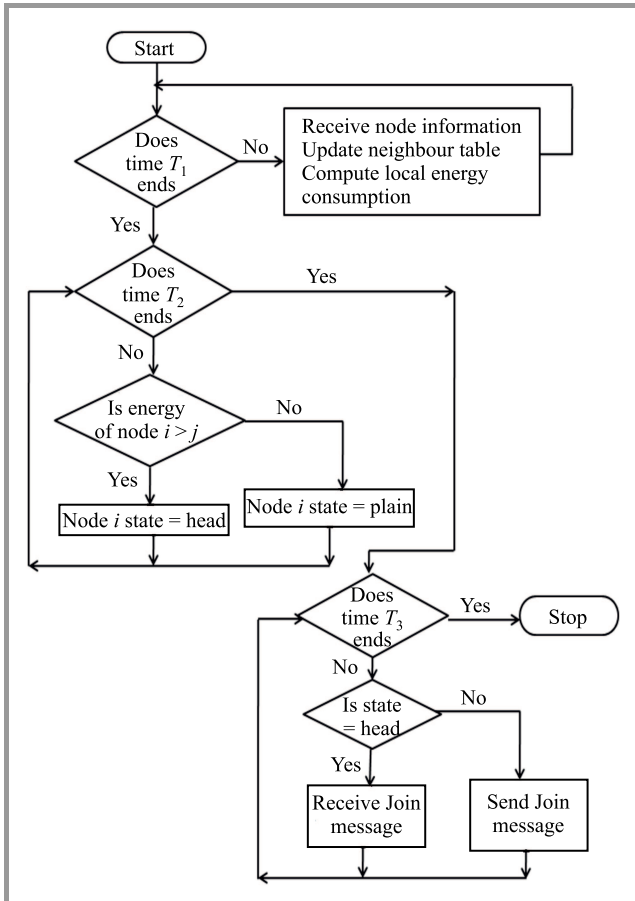

Fig. 7. Cluster setup based on local energy consumption ratio.

In the cluster formation phase, each node broadcasts a message with node ID and current remaining energy. After receiving the RSSI value from its neighbor node, each node computes its local energy consumption ratio. All nodes complete this process in time T_1 . If a node has a local energy consumption ratio that is lower than all other results, then it has a good chance of becoming a CH. At the end of time T_2 , if the node does not receive the HeadMsg and has more energy than other nodes, then it announces itself as CH. In time T_3 , if the state of the node is CH, then the node receives the Join message from a neighbor node. If a state of the node is Plain, then it sends the Join message to CH and becomes a CM.

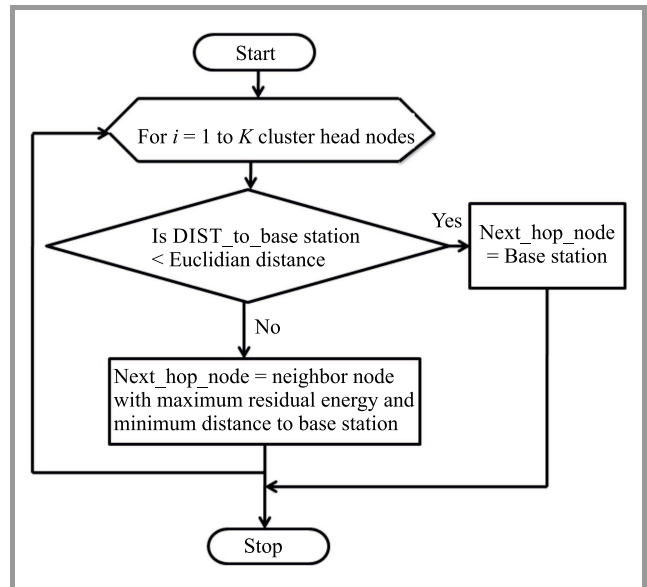

Fig. 8. Routing tree construction.

For inter-cluster communication, routing tree is constructed among CHs in the network, as depicted in Fig. 8. Each CH broadcasts the RouteMsg and checks whether the neighbor node has the highest residual energy and that its distance to BS is the lowest among the set of neighbor nodes. Next, CH i chooses its next-hop node as BS if its distance to BS is lower than Euclidean. Else, it selects node CH j that has a minimum distance to the base station and the lowest local energy consumption ratio among all its neighbor CH nodes.

4. Performance Evaluation

The performance of the proposed DSM technique has been evaluated using the NS2 simulator. The evaluation setup includes a random deployment of 120 nodes within an area measuring $1000 \text{ m} \times 500 \text{ m}$ area. The base station is positioned 50 m away from the deployment area, as shown in [26]. Figure 9 shows the simulation scenario consisting of 100 nodes positioned throughout the sensor field and a proxy server that supports energy-efficient data collection using the DSM protocol. The channel capacity is set to $3 \cdot 10^6$ for each node. IEEE 802.15.6 is used at the MAC layer. The simulated traffic is ECG-, pulse- and breath-generated at the application layer (Table 1).

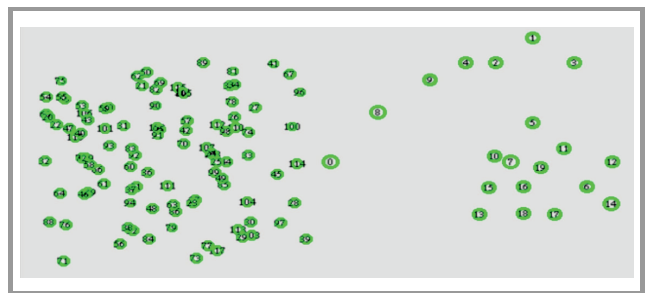

Fig. 9. Simulation scenario.

Table 1
Simulation parameters list

Parameter	Value
Total number of nodes	120
Number of clusters	15
Simulation time	200 s
Traffic source	CBR
Transmit power	0.2 J
Receive power	0.1 J
Initial energy	100 J
Number of user nodes among 120 nodes	10
Storage device	1
Service provider	6
Task divider	1
Proxy server	1
Sensor nodes	100

Performance of DSM was evaluated by varying packet size, simulation time and intervals. The results are obtained by varying packet size, interval and simulation time. Figure 10 shows that an increase in the data rate does not affect the packet delivery ratio, as the packet classifier forwards different packet types into various queues. Emergency and compressed packets in queue 1 and queue 2 are sent with a high priority and are not subjected to delays caused by large size packets in queue 3.

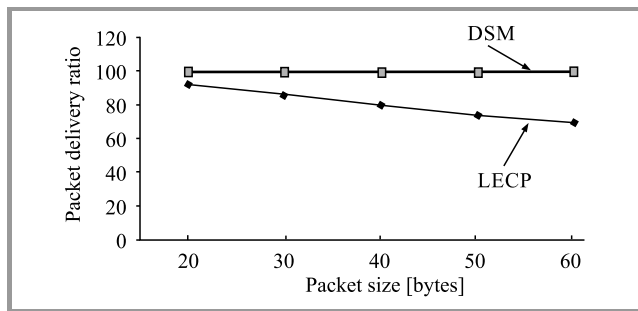

Fig. 10. Packet size versus packet delivery ratio.

As the data rate increases, DSM suffers from a minimal packet drop compared to LECP, thanks due to the separation of data packets into queues with different priority rates (Fig. 11).

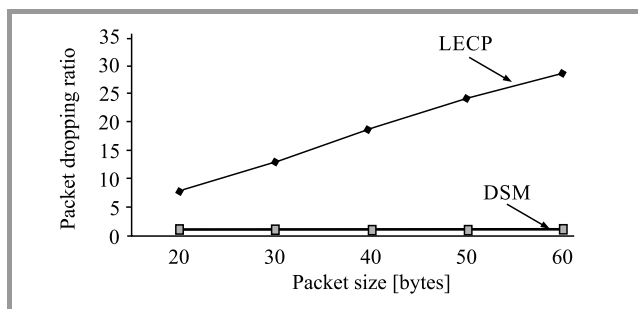

Fig. 11. Packet size versus packet dropping ratio.

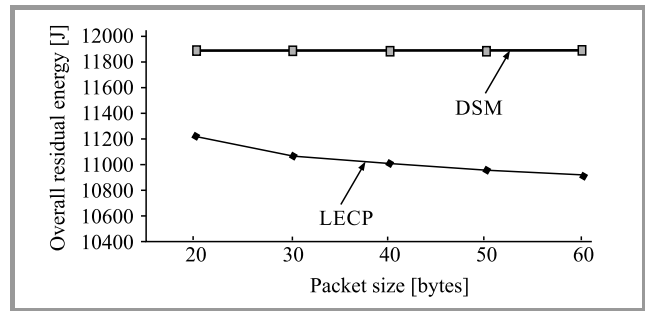

Fig. 12. Packet size versus overall residual energy.

Figure 12 shows that overall residual energy is minimized with an increase in packet size, as the sensor node performs a data size reduction if a shorter data reduction time is required. If the data reduction time at the sensor is high, then the data are sent to the proxy server for compression. Avoiding data reduction at the sensor node limits energy consumption. LECP needs 65% more energy compared to DSM.

The DSM method achieves a normalized routing overhead by transmitting data from each sensor node to CH in a cluster-based form, using a stochastic schedule [26] (Fig. 13).

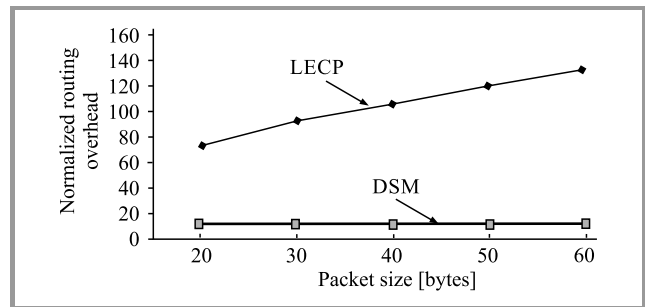

Fig. 13. Packet size versus normalized routing overhead.

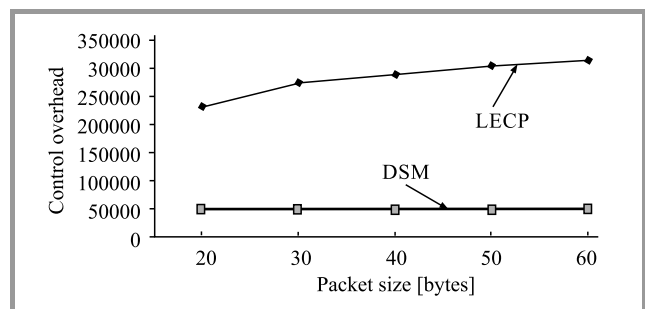

Fig. 14. Packet size versus control overhead.

Figure 14 shows that the DSM method has a decreased routing overhead compared to LECP, as there is no control message transfer overhead among the nodes. DSM balances the traffic load by separating packets into different service types and avoids packet drops by minimal interference between packets of same type. This, in turn, avoids retransmission and transfer of control messages.

The DSM method shows less jitter compared to LECP thanks to the distribution of packets via different flows (Fig. 15). The packets in each queue are subjected to a delay caused by the same type of packets, which may be lower and which generates minimized jitter with priority offered to emergency data packets.

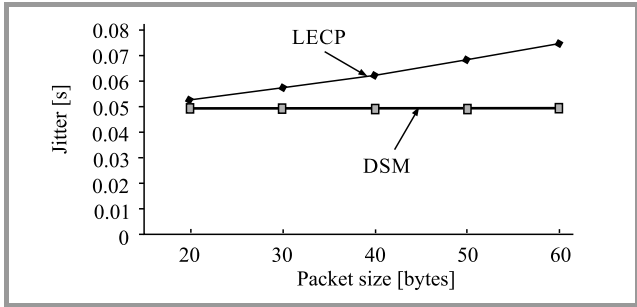

Fig. 15. Packet size versus jitter.

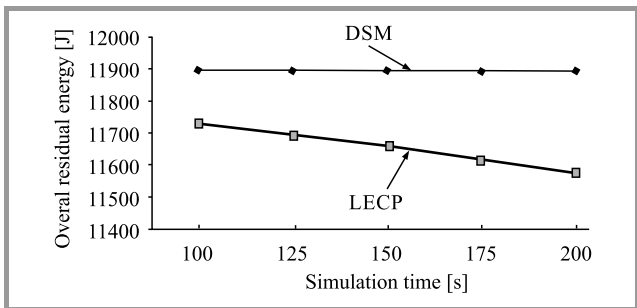

Fig. 16. Overall residual energy.

Figure 16 shows that the overall residual energy remains constant, with an increase in simulation time, as different traffic flows are used for different service classes. Such an approach avoids interferences between different packet types. LECP lacks this feature and packets flowing through the same path are subjected to more interference and delay, consequently leading to retransmissions.

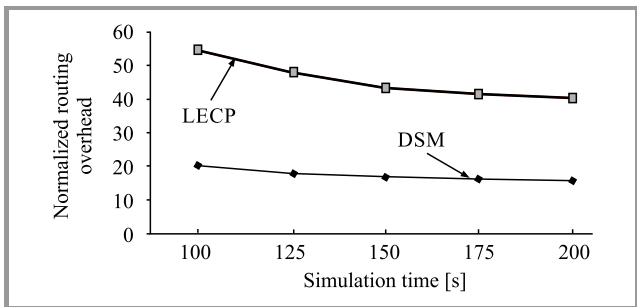

Fig. 17. Normalized routing overhead.

The DSM has a 25% lower normalized routing overhead due to the use of cluster-level node scheduling based on sensing error (Fig. 17). Also, DSM incurs a minimal delay compared to LECP, by using service differentiation and by prioritizing emergency data packets (Fig. 18). In

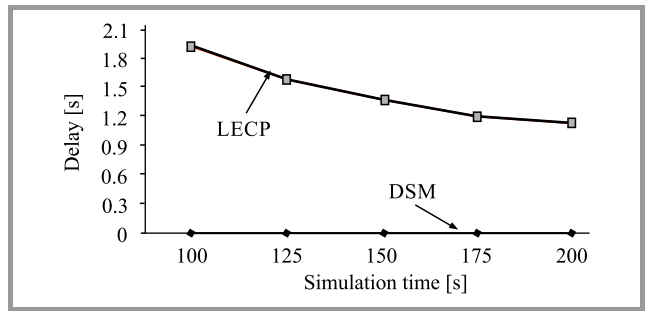

Fig. 18. Delay.

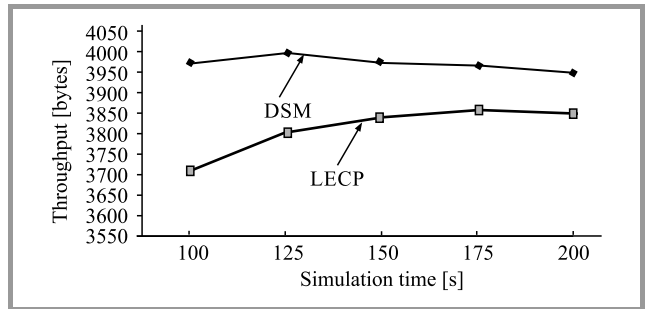

Fig. 19. Throughput comparison.

the case of LECP, large size packets may increase the delay for subsequent small size packets. Large size packets and small size packets are separated into different flows in DSM. The throughput is higher in DSM than in LECP thanks to the use of computation offloading (Fig. 19).

Next, simulations in the interval domain were performed. Here, the DSM method displays a constant and lower delay with the increasing number of packets (Fig. 20). At interval 6, with the maximum number packets, DSM shows a slight increase in delay that is lower, however, than 0.005 s, which is negligible compared to LECP that has a delay of 6.18 s for the same number of packets.

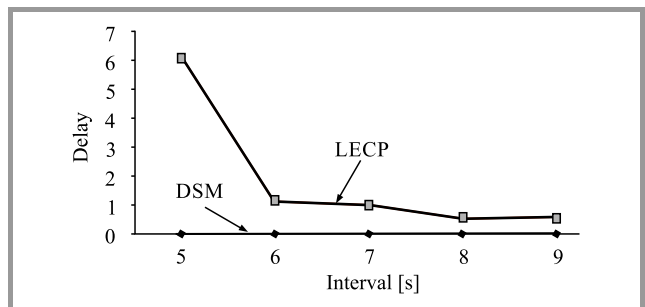

Fig. 20. Interval [s] vs. delay [s].

Figure 21 shows that throughput achieved using DSM is higher when compared to LECP, thanks to the scheduling of nodes and cluster-based routing. As the interval increases, the number of packets transmitted per second decreased, which – in turn – may lead to a less collision of packets. At the interval of 5 s, DSM achieves higher throughput compared to LECP for the transmission of a minimal number of packets.

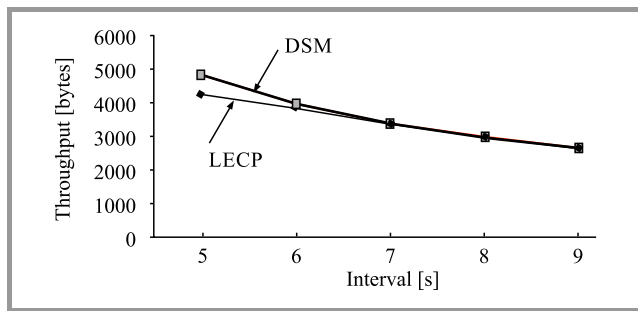

Fig. 21. Interval vs. throughput.

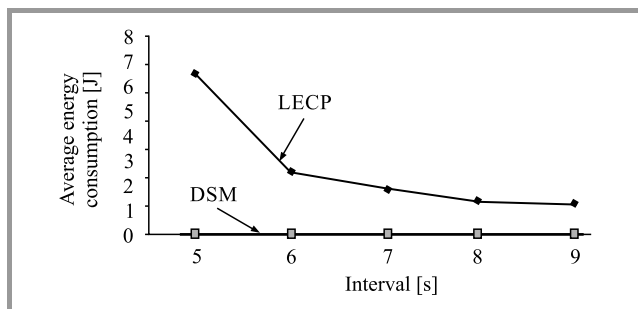

Fig. 22. Interval vs. average energy consumption.

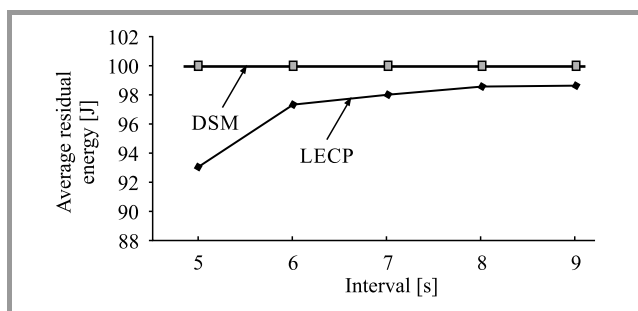

Fig. 23. Interval vs. average residual energy.

The average energy consumption observed in DSM is minimal compared to LECP, even with an increase in the number of packets, thanks to the use of offload computation as depicted in Fig. 22. Also, DSM achieves a higher average residual energy compared to LECP, with an increase in the number of packets per seconds as depicted in Fig. 23.

5. Conclusion

Avoiding delay is one of the most significant issues in critical data applications. The DSM method transfers time-critical data by assigning them with high priority and relies on service differentiation to separate data into emergency and non-emergency flows. Emergency data is sent with a top priority, while non-emergency data is compressed at the sensor node to minimize transmission energy consumption. If energy consumed at the sensor node is less than at the proxy server, then data reduction is carried out at the sensor node. If the data compression

at the sensor node consumes more energy than at the proxy server, then the data reduction task is offloaded to the proxy server in order to minimize the delay for emergency and small size packets. DSM helps differentiate between packets, providing higher service quality during the flow of data over the prioritized path, utilizing network bandwidth efficiently with a minimized delay and routing overheads.

References

- [1] I. Yoon, K. Hyeok, and N. Dong, "Adaptive data aggregation and compression to improve energy utilization in solar-powered wireless sensor networks", *Sensors*, vol. 17, no. 6, pp. 1226, 2017 (DOI: 10.3390/s17061226).
- [2] J. Yick, M. Biswanath, and G. Dipak, "Wireless sensor network survey", *Computer Netw.*, vol. 52, no. 12, pp. 393–422, 2002 (DOI: 10.1016/j.comnet.2008.04.002).
- [3] V. Raghunathan *et al.*, "Energy-aware wireless microsensor networks", *IEEE Sig. Process. Mag.*, vol. 19, no. 2, pp. 40–50, 2002 (DOI: 10.1109/79.985679).
- [4] V. Raghunathan, A. Kansal, J. Hsu, J. Friedman, and M. Srivastava, "Design considerations for solar energy harvesting wireless embedded systems", in *Proc. of the 4th Int. Symp. on Inform. Process. in Sensor Netw. IPSN 2005*, Boise, ID, USA, 2005, pp. 457–462 (DOI: 10.1109/IPSIN.2005.1440973).
- [5] M. Minami, T. Morito, H. Morikawa, and T. Aoyama, "Solar biscuit: A battery-less wireless sensor network system for environmental monitoring applications", in *Proc. of The 2nd Int. Works. on Network. Sensing Syst. INSS 2005*, San Diego, USA, 2005 [Online]. Available: <http://citeseerx.ist.psu.edu/viewdoc/download?doi=10.1.1.532.7036&rep=rep1&type=pdf>
- [6] S. Meninger *et al.*, "Vibration-to-electric energy conversion", *IEEE Trans. on Very Large Scale Integr. (VLSI) Syst.*, vol. 9, no. 1, pp. 64–76, 2001 (DOI: 10.1109/92.920820).
- [7] G. Otman, A. Bhatt, H. Hofmann, and G. Lesieutre, "Adaptive piezoelectric energy harvesting circuit for wireless, remote power supply", *IEEE Trans. on Power Electron.*, vol. 17, no. 5, 2002 (DOI: 10.1109/TPEL.2002.802194).
- [8] M. A. Weimer, T. S. Paing, and R. A. Zane, "Remote area wind energy harvesting for low-power autonomous sensors," in *Proc. 37th PESC Record – IEEE Ann. Power Electron. Spe. Conf. PESC'06*, Jeju, South Korea, 2006 (DOI: 10.1109/PESC.2006.1712213).
- [9] M. Stordeur and I. Stark, "Low power thermoelectric generator-self-sufficient energy supply for micro systems", in *Proc. 16th Int. Conf. on Thermoelec. ICT'97*, Dresden, Germany, 1997, pp. 575–577 (DOI: 10.1109/ICT.1997.667595).
- [10] C. B. Mudgule, U. Nagaraj, and P. D. Ganjewar, "Data compression in wireless sensor network: a survey", *Int. J. of Innov. Res. in Comp. and Commun. Engin.*, vol. 2, no. 11, pp. 6664–6673, 2014 [Online]. Available: http://www.ijrccce.com/upload/2014/november/66_Data.pdf
- [11] J. Agarkhed, G. S. Biradar, and V. D. Mytri, "Energy efficient QoS routing in multi-sink wireless multimedia sensor networks", *Int. J. of Comp. Sci. and Netw. Secur. (IJCSNS)*, vol. 12, no. 5, pp. 25–31, 2012 [Online]. Available: http://paper.ijcsns.org/07_book/201205/20120505.pdf
- [12] Q. Zhang *et al.*, "Collaborative scheduling in dynamic environments using error inference", *IEEE Trans. on Paralle. and Distrib. Syst.*, vol. 25, no. 3, pp. 591–601, 2013 (DOI: 10.1109/TPDS.2013.28).
- [13] J. Agarkhed and Y. D. Patil, "Energy efficient service differentiated QoS aware routing in cluster-based wireless sensor network", *Int. J. of Hybrid Intell.*, vol. 1, no. 1, pp. 79–95, 2019 (DOI: 10.1504/IJHI.2019.10021297).
- [14] J. Yu, L. Feng, L. Jia, X. Gu, and D. Yu, "A local energy consumption prediction-based clustering protocol for wireless sensor networks", *Sensors*, vol. 14, no. 12, pp. 23017–23040, 2014 (DOI: 10.3390/s141223017).

- [15] M. Younis, M. Youssef, and K. Arisha, "Energy-aware management for cluster-based sensor networks", *Computer Netw.*, vol. 43 no. 5, pp. 649–668, 2003 (DOI: 10.1016/S1389-1286(03)00305-0).
- [16] Y. T. Hou, Y. Shi, H. D. Sherali, and S. F. Midkiff, "On energy provisioning and relay node placement for wireless sensor networks", *IEEE Trans. on Wirel. Commun.*, vol. 4, no. 5, pp. 2579–2590, 2005 (DOI: 10.1109/TWC.2005.853969).
- [17] K. Akkaya and M. Younis, "A survey on routing protocols for wireless sensor networks", *Ad Hoc Netw.*, vol. 3 no. 3, pp. 325–349, 2005 (DOI: 10.1016/j.adhoc.2003.09.010).
- [18] M. Adamou, I. Lee, and I. Shin, "An energy efficient real-time medium access control protocol for wireless ad-hoc networks", Report-University of York Department of Computer Science YCS, 2001, pp. 5–8.
- [19] Y. Xu, J. Heidemann, and D. Estrin, "Geography-informed energy conservation for ad hoc routing", in *Proc. of the 7th Ann. Int. Conf. on Mob. Comput. and Network. MobiCom'01*, Rome, Italy, 2001, pp. 70–84 (DOI: 10.1145/381677.381685).
- [20] T. Wu and S. Biswas, "A self-reorganizing slot allocation protocol for multi-cluster sensor networks", in *Proc. of the 4th Int. Symp. on Inform. Process. in Sensor Netw. IPSN 2005*, Boise, ID, USA, 2005, pp. 309–316 (DOI: 10.1109/IPSIN.2005.1440940).
- [21] G. Jolly, and M. Younis, "An energy-efficient, scalable and collision-free MAC layer protocol for wireless sensor networks", *Wirel. Commun. and Mob. Comput.*, vol. 5, no. 3, pp. 285–304, 2005 (DOI: 10.1002/wcm.222).
- [22] K. Dasgupta, K. Kalpakis, and P. Namjoshi, "An efficient clustering-based heuristic for data gathering and aggregation in sensor networks", in *Proc. IEEE Wirel. Commun. and Network. WCNC 2003*, New Orleans, LA, USA, 2003, vol. 3, pp. 1948–1953 (DOI: 10.1109/WCNC.2003.1200685).
- [23] J. Agarkhed, P. Y. Dattatraya, and S. R. Patil, "Performance evaluation of QoS-aware routing protocols in wireless sensor networks", in *Proc. of the 1st Int. Conf. on Comput. Intell. and Inform.*, Singapore, 2017, pp. 559–569 (DOI: 10.1007/978-981-10-2471-9_54).
- [24] M. Amjad, M. K. Afzal, T. Umer, and B.-S. Kim, "QoS-aware and heterogeneously clustered routing protocol for wireless sensor networks", *IEEE Access*, vol. 5, pp. 10250–10262, 2017 (DOI: 10.1109/ACCESS.2017.2712662).
- [25] M. Maimour, "Maximally radio-disjoint multipath routing for wireless multimedia sensor networks", in *Proc. of the 4th ACM Worksh. on Wirel. Multim. Network. and Perform. Model. WMuNeP'08*, Vancouver, BC, Canada, 2008, pp. 26–31 (DOI: 10.1145/1454573.1454579).
- [26] N. Yessad, M. Omar, A. Tari, and A. Bouabdallah, "QoS-based routing in wireless body area networks: a survey and taxonomy", *Computing*, vol. 100, no. 3, pp. 245–275, 2018 (DOI: 10.1007/s00607-017-0575-4).



Jayashree Agarkhed is currently working as a Professor at the CSE Department of PDACE Kalaburagi, affiliated to VTU. She obtained her M.Tech. in CSE in 2003 and Ph.D. in 2013, both from VTU. Her main research areas are in wireless sensor networks, multimedia information networks, artificial intelligence, cloud computing, and

the Internet of Things. She has published more than 150 scientific articles in top-tier journals and has contributed to

numerous conferences and book chapters. She is an author of 2 books in the field of computer science.

 <https://orcid.org/0000-0003-3365-6498>

E-mail: jayashreeptl@yahoo.com

Department of CSE

Poojya Doddappa Appa College of Engineering
Kalaburagi, India



Patil Yogita Dattatraya is currently working as an Associate Professor at the Computer Science and Engineering Department of Sharnbasva University, Kalaburagi, and is pursuing a Ph.D. from Poojya Doddappa Appa (PDA) College of Engineering, Kalaburagi, affiliated to Visvesvaraya Technological University (VTU), Bela-

gavi. She obtained her B.E. from the Pune University and an M.Tech. in Computer Science and Engineering in 2010 from VTU. Her research focuses on wireless sensor networks, multimedia communication, cloud computing and the Internet of Things.

 <https://orcid.org/0000-0001-6478-3348>

E-mail: agyogita@gmail.com

Department of CSE

Sharnbasva University
Kalaburagi, India

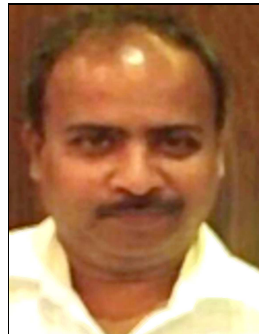

Siddarama R. Patil received his B.E. degree in Electronics and Communication Engineering from Gulbarga University, Gulbarga, Karnataka, India, M.Tech. in Telecommunication Engineering, and Ph.D. from the Indian Institute of Technology (IIT), Khargpur, India, in 1990, 1999 and 2009, respectively. Currently, he is a Profes-

sor in the Electronics, Communication and Engineering Department and Dean Academics of Poojya Doddappa Appa College of Engineering, Gulbarga, Karnataka, India. His current research includes information theory and coding, turbo codes, LDPC codes, iterative decoding algorithms, wireless sensor networks, mobile ad hoc networks and cognitive radio with more than 100 publications in top-tier journals.

 <https://orcid.org/0000-0002-7798-1359>

E-mail: pdapatil@gmail.com

Department of E&CE

Poojya Doddappa Appa College of Engineering
Kalaburagi, India