

Absorption of EM energy by human body in the vicinity of the GSM base station antenna

Dariusz Wójcik, Tomasz Topa, and Krzysztof Szczepański

Abstract— A hybrid method is proposed for specific absorption rate analysis in a human body located in the near field of typical GSM base-station panel antenna. The method combines FDTD technique with analytical description of the near field of isolated antenna. The approximate results are found to be in excellent agreement with the results obtained by using the traditional FDTD. The most important advantage of proposed approach is minimization of computer memory requirements and computation time.

Keywords— cellular telephony, GSM, human exposure to EM fields, antennas, near field, specific absorption rate.

1. Introduction

According to International Commission on Non-Ionizing Radiation Protection (ICNIRP) guidelines [1] and IEEE standards [2], to evaluate exposure conditions to EM fields specific absorption rate (SAR) must be calculated. It is advisable to use full-wave numerical methods to evaluate SAR [4]. Finite-difference in time domain (FDTD) method seems to be the most frequently used approach in such cases. The method has been successfully applied to evaluate exposure conditions in far-field of antennas [6], where plane-wave excitation can be assumed. However, evaluation of SAR in the vicinity of GSM base-station antenna using classical FDTD usually cannot be performed due to computational limitations. Since the FDTD domain should enclose antenna as well as human body phantom, while the distance between them increases the computer storage requirements and computational time grow rapidly. To overcome the limitations mentioned above, parallel FDTD tool using super-computing platforms has been proposed [8]. For the same purpose, hybrid method, combining method of moments (MoM) with finite elements method (FEM) has been employed [9].

In this paper, another hybrid approach to evaluation of human exposure conditions in near field of typical GSM base station panel antenna is proposed. The method combines FDTD [7] with analytical description of antenna's near field. To evaluate near field of the antenna, its discrete model is employed [10, 11, 12]. It must be stressed, that proposed approach can be used to evaluate exposure conditions even when antenna's geometry is not exactly known, while all needed parameters of antenna's model can be obtained from the catalogue data only. For proposed hybrid

method, computer requirements are independent of the distance between antenna and human body phantom.

2. Method description

In this section proposed hybrid method for evaluation human exposure conditions in near field of GSM antennas is described. The approximate results are compared with those obtained using traditional FDTD method. Because of huge computer memory requirements for traditional FDTD, derivation of the method and its validation is carried out for simple, rectangular box human phantom. Dimensions of the phantom (height \times width \times thickness = 80 \times 50 \times 20 cm) correspond roughly to dimensions of adult man's trunk, and its electrical parameters ($\epsilon_r = 42$, $\sigma = 0.97$ S/m) – to average parameters of human body for 900 MHz. The same phantom is recommended for SAR measurement procedure [4].

Let us consider the situation depicted in Fig. 1. The phantom is located centrally in front of 730370 antenna [15]. This antenna is widely used in GSM 900 base-stations. When the human phantom is located close to the source (in near field), significant influence on antenna parameters is expected. To examine this coupling phenomena, input admittance of the antenna as a function of the distance between antenna and phantom has been calculated.

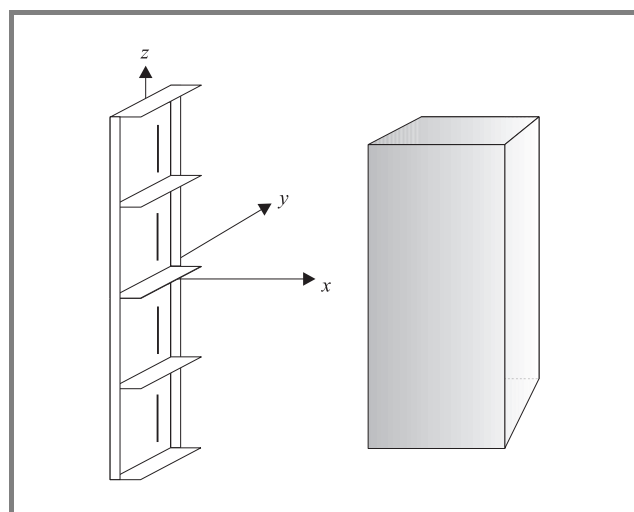

Fig. 1. Rectangular box phantom in the vicinity of GSM panel antenna.

The results are presented in Fig. 2. As can be observed, if the distance is greater than approximately 0.7–0.8 m, the phantom influence can be almost completely omitted.

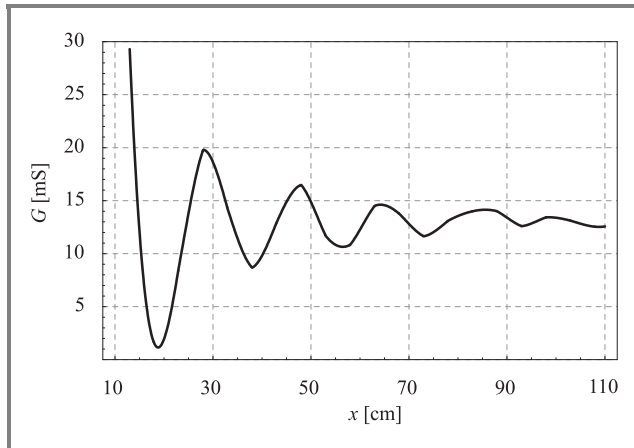

Fig. 2. Input conductance of panel antenna as a function of the distance between antenna and phantom.

The total field in the vicinity of the phantom can be treated as sum of incident field (E^i, H^i), produced by current flowing in the antenna, and scattered field (E^s, H^s), resulted from interaction of incident field with the phantom. If the influence of the phantom is negligible, current distribution in the antenna is such as current distribution in separated antenna. In such cases incident field can be successfully calculated using so-called discrete model [10]. Panel antennas, which seem to be the most popular for GSM 900 MHz as well as for GSM 1800 MHz base stations, are made up of identical “cells” (see Fig. 1). Each cell consists of several dipoles placed in front of a reflector. In discrete model, the original antenna is replaced with discrete linear array, where each cell is modelled by one source. The total field is calculated as a sum of the fields radiated by sources. The field of each source is obtained using far-field formulas. The model gives excellent results if observation point is located at the distance greater than $\sim 2\lambda$ from the antenna. All needed parameters of discrete model can be evaluated from catalogue data of the antenna only [10, 13, 14]. Thus, the model can be used for fast calculation of incident field even if antenna’s geometry is not exactly known. To evaluate exposure conditions, knowledge of total field only inside human phantom is needed. Consequently, if discrete model is employed for incident field calculation, problem space for FDTD method can be significantly reduced to the nearest vicinity of the phantom, as it is illustrated in Fig. 3. It results in decrease of needed computer memory and time of computations. In this paper FDTD formulation for total/scattered field is used. Thus, discrete model is employed only for calculation of incident field on the Huygens boundary between regions. To extend FDTD domain to infinity, Berenger’s perfectly matched layer (PML) [7] has been used.

In order to validate the proposed method, approximate results has been compared with those obtained using classi-

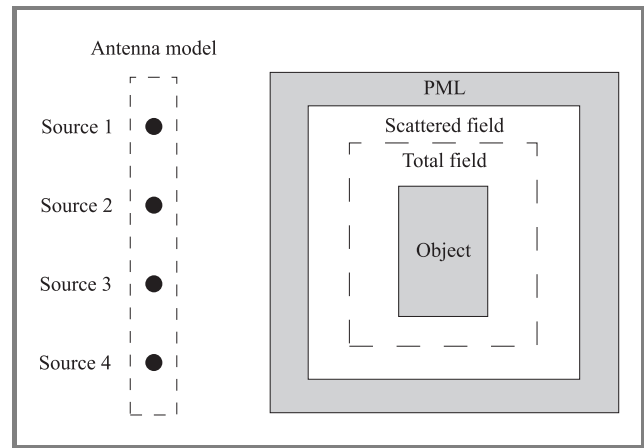

Fig. 3. Problem space for proposed hybrid method.

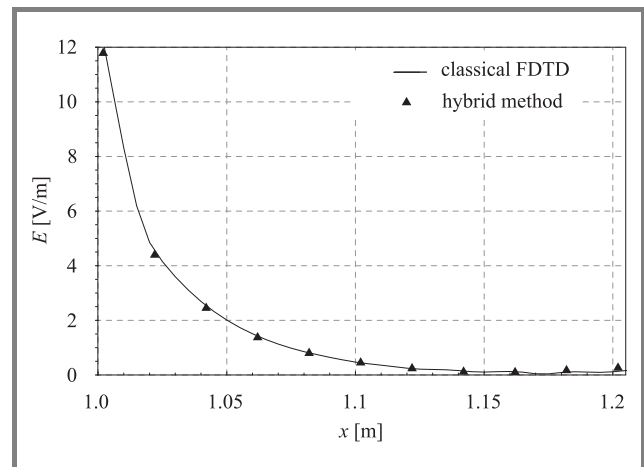

Fig. 4. Electric field intensity [V/m] inside the phantom along its symmetry axis.

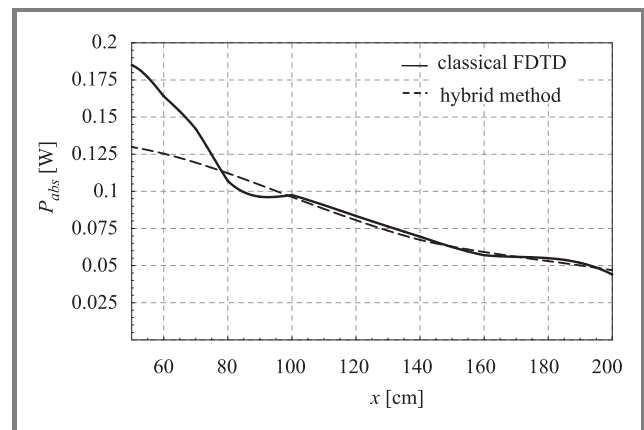

Fig. 5. Total power [W] absorbed by the phantom as a function of the distance ($f = 900$ MHz, $P_{in} = 1$ W).

cal FDTD. Calculations has been carried out for numerous distances between antenna and phantom. In Fig. 4, electric field intensity inside the phantom along its symmetry axis is presented. Total power absorbed by the phantom as a function of distance is depicted in Fig. 5. As can be

easily observed, excellent agreement has been obtained for the distances greater than ~ 0.9 m.

3. Results

To study exposure conditions in the near field of base station antenna heterogenous model of man has been used. The computer phantom, which has been developed by visible human data [16] and provided by American National Library of Medicine, carries information about parameters of 39 different types of tissues. Used model is made up of $196 \times 114 \times 626$ voxels with 3 mm resolution.

The following conditions have been considered. The phantom faces the 730370 antenna, so that the maximum of radiated field can be observed at head-level. The distance between the antenna and the phantom was being changed from 0.75 m to 10 m, which is far field boundary according to classical $2D^2/\lambda$ criterion [5], with 0.25 m step. For each distance electric field intensity E in human body was calculated and then SAR distribution was obtained:

$$SAR = \sigma E^2 / \rho,$$

where σ and ρ denote conductivity and density of the tissue, respectively. Then, the results was compared to safety guidelines. IEEE and ICNIRP restrictions are based on limitation of whole-body SAR and local SAR for any 10 g [1] or 1 g [2] of continuous tissues. To select a tissue volume of the specified SAR-averaged-mass, the techniques described in [3] has been employed. According to [3] only a 5% deviation of demanded mass is permitted, and a tissue volume must have a cubical shape. It is easy to satisfy such conditions if a 10 g mass averaging is evaluated. Some difficulties may occur when a 1 g mass average SAR evaluations have to be proceeded, because of a 3 mm phantom resolution. If it is not possible to reach the desired value of the required mass in cubical volume, the following method has been developed. All the voxels in the vicinity of centered location [3] have been divided into 27 subvoxels. Each subvoxel has mass equal to 1/27 mass of a basic voxel, and a resolution of 1 mm. Thus, it is possible to create a precise cube with a required mass of tissue. In Figs. 6 and 7 SAR distribution in two cross-sections of the man model located at the distance of 1.5 m are presented for power radiated by the antenna equals to 10 W.

Table 1

Tissues with most intensive power absorption

Part of body	SAR _{tis} /SAR _{wb}				
	Distance [m]				
	0.6	1.5	3.5	6.0	8.0
Eye lens	26.71	40.53	32.52	23.61	19.26
Eye cornea	18.67	27.91	22.24	16.16	13.15
Eye aqueous humor	14.19	22.05	17.70	12.85	10.47
Eye sclera/wall	11.73	18.23	14.82	10.63	8.71
Pituitary gland	10.92	15.81	12.77	9.31	7.62

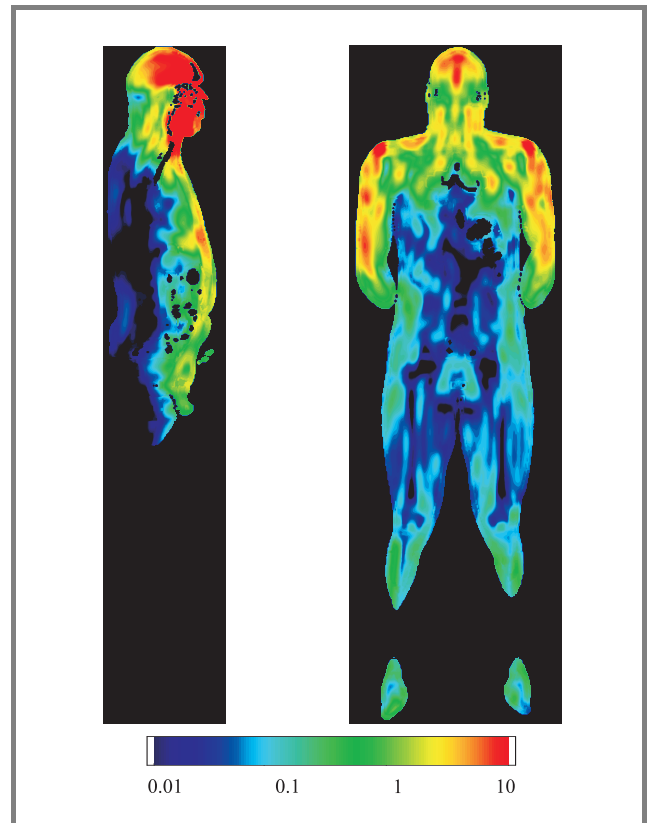

Fig. 6. SAR_{1g} distribution on sagittal and coronal views for distance 1.5 m ($f = 900$ MHz, $P_{in} = 10$ W).

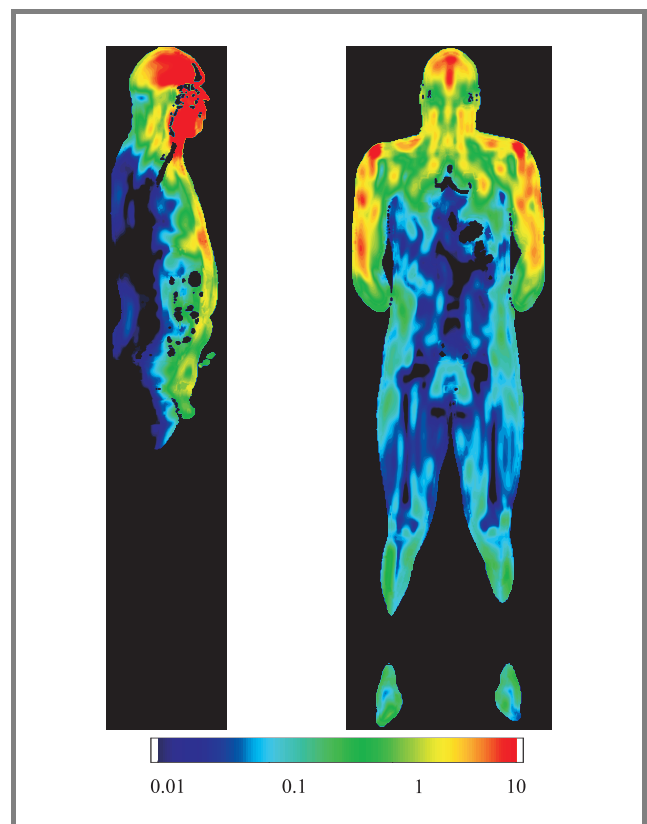

Fig. 7. SAR_{10g} distribution on sagittal and coronal views for distance 1.5 m ($f = 900$ MHz, $P_{in} = 10$ W).

For each considered distances most of electromagnetic energy is absorbed by muscles ($\sim 40\%$), fat ($\sim 25\%$) and skin ($\sim 5\%$). The investigation also shows that except brain and eyes, the other body organs are strongly protected by tissue layers such as muscle, fat, bone and skin. Some brain and eye-tissues absorb EM energy significantly more intensively compared with the rest of the body, as it is presented in the Table 1. Maximal local SAR values are concentrated around the head and chest, where distinct hot-spots can be observed. For example maximum local SAR is localized in eye when the distance between model and antenna is equal to 1.5 m. When the distance is increased to 8 m maximum local SAR occurs in muscle of chest.

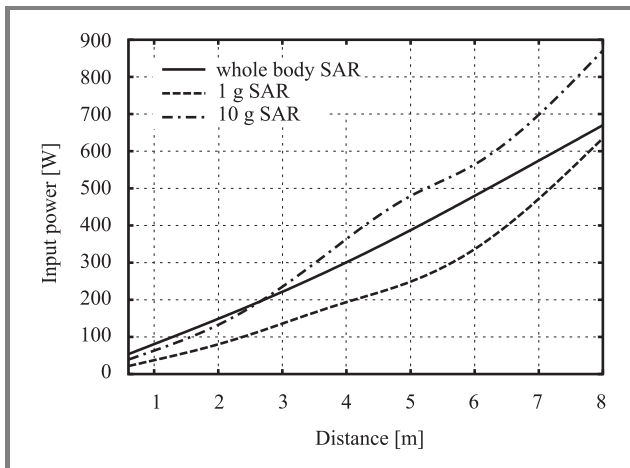

Fig. 8. Antenna input power needed to exceed SAR restrictions.

The results depicted in Fig. 8 show minimal antenna input power which makes the SAR restriction to be exceeded. As can be observed, to reach 1 g SAR restrictions the smallest input power level is sufficient. 10 g restrictions play important role close to antenna only – if the distance is greater then about 3 m whole-body SAR restrictions dominate.

4. Conclusion

In this paper hybrid method for specific absorption rate calculation in near field of GSM panel antenna is proposed. The method combines FDTD technique with analytical description of the near field of isolated antenna. The approximate results are found to be in excellent agreement with the results carried out by using the traditional FDTD. Obtained results show, that comparatively high SAR level can be observed in brain and eye tissues. However, it is also presented, that SAR restrictions can be exceeded if input power of the antenna is relatively high compared to its typical values (about 40 W).

References

- [1] "ICNIRP Guidelines. Guidelines for limiting exposure to time-varying electric, magnetic, and electromagnetic fields (up to 300 GHz)", *Health Phys.*, vol. 47, no. 4, pp. 494–532, 1998.

- [2] "IEEE Standard for safety levels with respect to human exposure to radio frequency electromagnetic fields, 3 kHz to 300 GHz", IEEE Std. C95.1, 1999.
- [3] "IEEE Recommended Practice for Measurements and Computations of Radio Frequency Electromagnetic Fields with Respect to Human Exposure to Such Fields, 100 kHz–300 GHz", IEEE Std. C95.3–2002, 11 Dec. 2002.
- [4] "Basic standard for the calculation and measurement of the human exposure to electromagnetic fields from radio base stations and fixed terminal stations for wireless telecommunication systems (110 MHz to 40 GHz)", TC 211, EN 50383.
- [5] C. A. Balanis, *Antenna Theory. Analysis and Design*. New York: Wiley, 1997.
- [6] P. Bernardi, M. Cavagnaro, S. Pisa, and E. Piuze, "Human exposure to radio base-station antennas in urban environment", *IEEE Trans. Microw. Theory Techn.*, vol. 48, no. 11, pp. 1996–2001, 2000.
- [7] A. Taflov and S. C. Hagness, *Computational Electromagnetics: The Finite-Difference Time-Domain Method*. Boston, London: Artech House, 2000.
- [8] L. Catarinucci, P. Palazzari, and L. Tarricone, "Human exposure to the near field of radiobase antennas – a full wave solution using parallel FDTD", *IEEE Trans. Microw. Theory Techn.*, vol. 51, no. 3, pp. 935–940, 2003.
- [9] R. J. Spiegel, M. B. A. Fatmi, S. Stuchly, and M. Stuchly, "Comparison of finite-difference time-domain SAR calculations with measurements in a heterogeneous model of man", *IEEE Trans. Biomed. Eng.*, vol. 36, no. 8, pp. 849–858, 1989.
- [10] M. Bizzi and P. Gianola, "Electromagnetic fields radiated by GSM antennas", *Electron. Lett.*, vol. 35, no. 11, pp. 855–857, 1999.
- [11] R. Mawrey, T. Riley, J. Higgins, and S. Slayden, "Predicting power density near antennas to meet FCC RF safety regulation", *Mob. Radio Technol.*, pp. 36–47, Sept. 1997.
- [12] D. Wójcik, "Evaluation of near field of the GSM base station antennas in urban environment", *J. Telecommun. Inform. Technol.*, no. 1, pp. 41–44, 2003.
- [13] D. Wójcik, "Near field of the base-station antennas of the cellular telephony", Ph.D. thesis, Gliwice, Silesian University of Technology, 2004 (in Polish).
- [14] D. Wójcik, "Simply method for evaluation of the near field of the GSM base-station antennas", in *17th Int. Wrocław Symp. Exhib. Electromagnet. Compat.*, Wrocław, Poland, 2004, pp. 127–130.
- [15] "Kathrein – Antennas for Mobile Communications". Version 4, Ed. 05/00.
- [16] "The Visible Human Project", http://www.nlm.nih.gov/research/visible/visible_human.html



Dariusz Wójcik was born in Czeladź, Poland, in 1974. He received the M.Sc. degree in telecommunications and Ph.D. degree in radiocommunications from the Silesian University of Technology, Gliwice, Poland, in 1999 and 2004, respectively. His professional interests are primarily in computational electromagnetics (MoM, FDTD, hybrid methods) and radiocommunications.

e-mail: dariusz.wojcik@polsl.pl
 Institute of Electronics
 Silesian University of Technology
 Akademicka st 16
 44-100 Gliwice, Poland



Tomasz Topa was born in Tarnowskie Góry, Poland, on April 8, 1977. He received the M.Sc. degree in telecommunications from Silesian University of Technology, Gliwice, Poland, in 2002. His current research interests include electromagnetic field theory, numerical dispersion, perfectly matched layers in FDTD method, the

FDTD method, and electromagnetic compatibility.

e-mail: tomasz.topa@polsl.pl

Institute of Electronics

Silesian University of Technology

Akademicka st 16

44-100 Gliwice, Poland



Krzysztof Szczepański was born in Będzin, Poland, in 1978. He received the M.Sc. degree in telecommunications from Silesian University of Technology, Gliwice, Poland, in 2003. His main research interests are computational electromagnetic and electromagnetic compatibility.

e-mail: krzysztof.szczepanski@polsl.pl

Institute of Electronics

Silesian University of Technology

Akademicka st 16

44-100 Gliwice, Poland